

BD-E8500A

BD-E8900A

BD-HDD Combo

user manual

imagine the possibilities

Thank you for purchasing this Samsung product.

To receive more complete service,
please register your product at

www.samsung.com/register



Safety Information

Warning

TO REDUCE THE RISK OF ELECTRIC SHOCK, DO NOT REMOVE THE COVER (OR BACK). NO USER-SERVICEABLE PARTS ARE INSIDE. REFER SERVICING TO QUALIFIED SERVICE PERSONNEL.

	CAUTION RISK OF ELECTRIC SHOCK DO NOT OPEN	
This symbol indicates "dangerous voltage" inside the product that presents a risk of electric shock or personal injury.	CAUTION: TO REDUCE THE RISK OF ELECTRIC SHOCK, DO NOT REMOVE COVER (OR BACK) NO USER SERVICEABLE PARTS INSIDE. REFER SERVICING TO QUALIFIED SERVICE PERSONNEL.	This symbol indicates important instructions accompanying the product.

Do not install this equipment in a confined space such as a bookcase or similar unit.

WARNING

- To prevent damage which may result in fire or electric shock hazard, do not expose this appliance to rain or moisture.

CAUTION

- BD-HDD COMBO USES AN INVISIBLE LASER BEAM WHICH CAN CAUSE HAZARDOUS RADIATION EXPOSURE IF DIRECTED. BE SURE TO OPERATE BD-HDD Combo CORRECTLY AS INSTRUCTED.

CAUTION

THIS PRODUCT UTILIZES A LASER. USE OF CONTROLS OR ADJUSTMENTS OR PERFORMANCE OF PROCEDURES OTHER THAN THOSE SPECIFIED HEREIN MAY RESULT IN HAZARDOUS RADIATION EXPOSURE. DO NOT OPEN COVERS AND DO NOT REPAIR YOURSELF. REFER SERVICING TO QUALIFIED PERSONNEL.

This product satisfies CE regulations when shielded cables and connectors are used to connect the unit to other equipment. To prevent electromagnetic interference with electric appliances, such as radios and televisions, use shielded cables and connectors for connections.

IMPORTANT NOTE

The mains lead on this equipment is supplied with a molded plug incorporating a fuse. The value of the fuse is indicated on the pin face of the plug. If it requires replacing, a fuse approved to BS1362 of the same rating must be used.

Never use the plug with the fuse cover omitted if the cover is detachable. If a replacement fuse cover is required, it must be of the same colour as the pin face of the plug. Replacement covers are available from your dealer.

If the fitted plug is not suitable for the power points in your house or the cable is not long enough to reach a power point, you should obtain a suitable safety approved extension lead or consult your dealer for assistance.

However, if there is no alternative to cutting off the plug, remove the fuse and then safely dispose of the plug. Do not connect the plug to a mains jack, as there is a risk of shock hazard from the bared flexible cord.

To disconnect the apparatus from the mains, the plug must be pulled out from the mains socket, therefore the mains plug shall be readily operable.

The product unit accompanying this user manual is licenced under certain intellectual property rights of certain third parties.

CLASS 1 LASER PRODUCT

This Compact Disc player is classified as a CLASS 1 LASER product. Use of controls, adjustments or performance of procedures other than those specified herein may result in hazardous radiation exposure.

CAUTION :

- CLASS 3B VISIBLE AND INVISIBLE LASER RADIATION WHEN OPEN. AVOID EXPOSURE TO THE BEAM (IEC 60825-1)
- THIS product UTILIZES A LASER. USE OF CONTROLS OR ADJUSTMENTS OR PERFORMANCE OF PROCEDURES OTHER THAN THOSE SPECIFIED HEREIN MAY RESULT IN HAZARDOUS RADIATION EXPOSURE. DO NOT OPEN COVER AND DO NOT REPAIR YOURSELF. REFER SERVICING TO QUALIFIED PERSONNEL.

CLASS 1	LASER PRODUCT
KLASSE 1	LASER PRODUKT
LUOKAN 1	LASER LAITE
KLASS 1	LASER APPARAT
PRODUCTO	LÁSER CLASE 1

Precautions

Important Safety Instructions

Read these operating instructions carefully before using the unit. Follow all the safety instructions listed below.

Keep these operating instructions handy for future reference.

1. Read these instructions.
2. Keep these instructions.
3. Heed all warnings.
4. Follow all instructions.
5. Do not use this apparatus near water.
6. Clean only with a dry cloth.
7. Do not block any ventilation openings. Install in accordance with the manufacturer's instructions.
8. Do not install near any heat sources such as radiators, heat registers, stoves, or other apparatus (including AV receivers) that produce heat.

9. Do not defeat the safety purpose of the polarized or grounding-type plug. A polarized plug has two blades with one wider than the other. A grounding type plug has two blades and a third grounding prong. The wide blade or the third prong are provided for your safety. If the provided plug does not fit into your outlet, consult an electrician for replacement of the obsolete outlet.
10. Protect the power cord from being walked on or pinched particularly at plugs, convenience receptacles, and the point where it exits the apparatus.
11. Only use attachments/accessories specified by the manufacturer.
12. Use only with the cart, stand, tripod, bracket, or table specified by the manufacturer, or sold with the apparatus. When a cart is used, use caution when moving the cart/apparatus combination to avoid injury from tip-over. 
13. Unplug this apparatus during lightning storms or when unused for long periods of time.
14. Refer all servicing to qualified service personnel. Servicing is required when the apparatus has been damaged in any way, such as when the power-supply cord or plug is damaged, liquid has been spilled or objects have fallen into the apparatus, the apparatus has been exposed to rain or moisture, does not operate normally, or has been dropped.

Disc Storage & Management

- Holding Discs
 - Fingerprints or scratches on the disc may reduce sound and picture quality or cause skipping
 - Avoid touching the surface of a disc where data has been recorded.
 - Hold the disc by the edges so that fingerprints will not get on the surface.
 - Do not stick paper or tape on the disc.
- 

Safety Information

• Cleaning Discs

- If you get fingerprints or dirt on the disc, clean it with a mild detergent diluted in water and wipe with a soft cloth.
- When cleaning, wipe gently from the inside to the outside of the disc.



• Disc Storage

- Do not keep in direct sunlight.
- Keep in a cool ventilated area.
- Keep in a clean protection jacket and store vertically.

Handling Cautions

- Do not expose this apparatus to dripping or splashing. Do not put objects filled with liquids, such as vases on the apparatus.
- To turn this apparatus off completely, you must pull the power plug out of the wall socket. Consequently, the power plug must be easily and readily accessible at all times.
- Do not touch the power plug with a wet hand. Otherwise, it can cause an electric shock.
- Do not plug multiple electric devices into the same wall socket. Overloading a socket can cause it to overheat, resulting in a fire.
- Maintenance of Cabinet.
 - Before connecting other components to this product, be sure to turn them off.
 - If you move your product suddenly from a cold place to a warm place, condensation may occur on the operating parts and lens and cause abnormal disc playback. If this occurs, unplug the product, wait for two hours, and then connect the plug to the power outlet. Then, insert the disc, and try to play back again.
- If the product makes an abnormal noise or produces a burning smell or smoke, turn off the power switch immediately and disconnect the power plug from the wall outlet. Then, contact the nearest customer service centre for technical assistance. Do not use the product. Using the product as it is may cause a fire or an electric shock.

Using the 3D function



IMPORTANT HEALTH AND SAFETY INFORMATION FOR 3D PICTURES.

Read and understand the following safety information before using the 3D function.

- Some viewers may experience discomfort while viewing 3D TV such as dizziness, nausea, and headaches.

If you experience any such symptom, stop viewing 3D TV, remove the 3D Active Glasses, and rest.

- Watching 3D images for an extended period of time may cause eye strain. If you feel eye strain, stop viewing 3D TV, remove your 3D Active Glasses, and rest.
- A responsible adult should frequently check on children who are using the 3D function. If there are any reports of tired eyes, headaches, dizziness, or nausea, have the child stop viewing 3D TV and rest.
- Do not use the 3D Active Glasses for other purposes. (Such as general eyeglasses, sunglasses, protective goggles, etc.)
- Do not use the 3D function or 3D Active Glasses while walking or moving around. Using the 3D function or 3D Active Glasses while moving around may cause you to bump into objects, trip, and/or fall, and cause serious injury.
- When displaying 3D programme with this model, the actual screen may appear as shown below:

Screen Display		Description
	Side by Side	Same screen duplicates horizontally.
	Top & Bottom	Same screen duplicates vertically.

- 3D programme reception, recording and playback of this model may not fully support 3D, due to the 3D broadcast format is not yet standardized worldwide. It is not the product's malfunction or disorder.

- If you want to enjoy 3D content, connect a 3D device (3D compliant AV receiver or TV) to the product's HDMI OUT port using a high-speed HDMI cable. Put on 3D glasses before playing the 3D content.
- The product outputs 3D signals only through HDMI cable connected to the HDMI OUT port.
- As the video resolution in 3D play mode is fixed according to the resolution of the original 3D video, you can not change the resolution to your preference.
- Some functions such as BD Wise, screen size adjustment, and resolution adjustment may not operate properly in 3D play mode.
- You must use a high-speed HDMI cable for proper output of the 3D signal.
- Stay at least three times the width of the screen from the TV when watching 3D images. For example, if you have a 46-inch screen, stay 138 inches (11.5 feet) from the screen.
- Place the 3D video screen at eye level for the best 3D picture.
- When the product is connected to some 3D devices, the 3D effect may not function properly.
- "Blu-ray 3D" and "Blu-ray 3D" logo are trademarks of the Blu-ray Disc Association.

Copyright

© 2012 Samsung Electronics Co.,Ltd.

All rights reserved; No part or whole of this user's manual may be reproduced or copied without the prior written permission of Samsung Electronics Co.,Ltd.

Contents

SAFETY INFORMATION

- 2 **Warning**
- 3 **Precautions**
- 3 Important Safety Instructions
- 3 **Disc Storage & Management**
- 4 **Handling Cautions**
- 4 **Using the 3D function**
- 5 **Copyright**

GETTING STARTED

- 8 **Disc and Format Compatibility**
- 8 Disc types and contents your product can play
- 8 Disc types your product cannot play
- 8 Available Recording Time for internal HDD
- 9 Region Code
- 9 Logos of Discs the product can play
- 10 Supported Formats
- 13 **Accessories**
- 14 **Front Panel**
- 14 **Rear Panel**
- 15 **Remote Control**

CONNECTIONS

- 17 **Connecting to a TV with an Audio/Video cables and RF cable**
- 18 **Connecting to a TV**
- 18 **Method 1** Using an HDMI cable (not included) - Best Quality (Recommended)
- 18 **Method 2** Using a Video and an Audio cable - Good Quality
- 19 **Connecting to an Audio System**
- 19 **Method 1** Connecting to an HDMI supported AV receiver
- 19 **Method 2** Connecting to an AV receiver with Optical input
- 19 **Method 3** Connecting to a Stereo Amplifier with an Audio Cable
- 20 **Connecting to a Network Router**
- 20 Wired Network
- 20 Wireless Network

SETTINGS

- 21 **The Setup Procedure**
- 21 **The Home Screen**
- 21 **Accessing the Settings Screen**
- 22 Buttons on the Remote Control used for the Settings menu
- 23 **Settings Menu Functions**
- 31 **Networks and the Internet**
- 31 Configuring Your Network Connection
- 33 Wi-Fi Direct
- 34 Soft AP
- 35 AllShare Settings
- 35 Device Name
- 35 **Upgrading Software**
- 35 Online
- 36 By Channel
- 36 By USB
- 36 By Disc
- 37 By Downloaded
- 37 Standby Mode Upgrade

MEDIA PLAY

- 38 **Insert a Disc to the Disc tray**
- 38 **Insert a USB or Mobile Phone to the USB port**
- 38 **Accessing the AllShare Play Screen**
- 39 **Using the AllShare Play Function**
- 40 To download the AllShare software
- 41 Playing content located in your PC on the BD-HDD Combo
- 41 Playing content located in your Mobile device on the BD-HDD Combo
- 41 Controlling with your mobile device
- 42 **Controlling Video Playback**
- 42 Buttons on the Remote Control used for Video Playback
- 42 Using the Tools Menu

- 44 **Controlling Music Playback**
- 44 Buttons on the Remote Control used for Music Playback
- 44 Using the Tools Menu
- 44 Repeating Tracks on an Audio CD
- 44 Shuffling Tracks on an Audio CD
- 45 Creating a Playlist from a CD
- 45 Ripping
- 45 AMG (All Media Guide) function
- 46 **Playing Photo Contents**
- 46 Using the Tools Menu
- 46 **Using the Tools Menu when a file is highlighted**

DTV FUNCTIONS

- 49 **Watching TV Channels**
- 49 Using the Tools Menu
- 50 Using the PIP (Picture-In-Picture) function
- 50 **Editing Channels**
- 50 Channel List
- 50 Channel Screen
- 51 Using the Tools Menu
- 51 **Viewing the Guide Screen**
- 52 **Schedule Manager**
- 52 **Using the Teletext Service**

ADVANCED FUNCTION

- 54 **Recording**
- 54 Checking Available Storage Size
- 54 Recording the current TV channel you are watching
- 55 Simultaneous Recording
- 55 Timeshift function
- 57 **Playing the Recorded Title**
- 57 **Editing the Recorded Title**
- 57 Splitting a Section of a Title (Divide into two)
- 58 Splitting a Section of a Title (Partial Delete)
- 58 **Copy**
- 58 Copying Videos, Music or Photos
- 58 **3D Functions**
- 58 3D Converter
- 59 Adjusting the 3D Depth
- 59 Viewing DTV with the 3D effect

NETWORK SERVICES

- 60 **Using Smart Hub**
- 60 Smart Hub at a Glance
- 61 Using the Web Browser
- 62 **BD-LIVE™**
- 62 **Samsung Smart View**
- 62 Dual View

APPENDIX

- 63 **Compliance and Compatibility Notice**
- 64 **Copy Protection**
- 64 **Network Service Disclaimer**
- 65 **Licence**
- 68 **Additional Information**
- 74 **Troubleshooting**
- 76 Repairs
- 77 **Specifications**

Disc and Format Compatibility

Disc types and contents your product can play

Contents	Media	Details
VIDEO	Blu-ray Disc 3D Blu-ray Disc	BD-ROM or BD-RE/R disc recorded in the BD-RE format.
	DVD-VIDEO DVD±RW/±R CD-RW/R	DVD-VIDEO, DVD±RW/±R discs that have been recorded and finalized. Media containing DivX, MKV or MP4 contents.
MUSIC	CD-RW/R DVD±RW/±R BD-RE/R	Music recorded on CD-RW/R, DVD±RW/±R, BD-RE/R containing MP3 or WMA contents.
PHOTO	CD-RW/R DVD±RW/±R BD-RE/R	Photos recorded on CD-RW/R, DVD±RW/±R, BD-RE/R media containing JPEG contents.
VIDEO MUSIC PHOTO	HDD USB	Video, music and photos stored in HDD or USB.

* For more information on the file format, refer to pages 10~12.

Disc types your product cannot play

- HD DVD
- DVD-ROM/PD/MV-Disc, etc
- DVD-RAM
- Super Audio CD (except CD layer)
- DVD-RW(VR mode)
- CVD/CD-ROM/CDV/CD-G/CD-I/LD (CD-Gs play audio only, not graphics.)
- 3.9 GB DVD-R for Authoring.

NOTE

- ▶ The product may not play certain CD-RW/R and DVD±RW/±R because of the recording conditions.
- ▶ If a DVD±RW/±R has not been recorded properly in DVD video format, it will not be playable.
- ▶ Your product will not play content that has been recorded on a DVD±RW/±R at a bit-rate that exceeds 10Mbps.
- ▶ Your product will not play content that has been recorded on a BD-RE/R at a bit rate that exceeds 25Mbps.
- ▶ Playback may not work for some types of discs, or when you use specific operations, such as angle change and aspect ratio adjustment. Information about the discs is written in detail on the disc box. Please refer to this if necessary.
- ▶ When you play a BD-J title, loading may take longer than a normal title or some functions may perform slowly.

Available Recording Time for internal HDD

You can record digital broadcast on the internal HDD as below.

Depending on the actual broadcast, available recording time may be different with the table shown below
In On Screen Display, you can check available recording time as shown in "high" case in the table shown below.

Broadcast Type	Estimated Bitrate	Recording Time	
		BD-E8900A	BD-E8500A
HD	20Mbps	102 Hours	49 Hours
SD	5Mbps (Normal)	411 Hours	199 Hours
	10Mbps (High)	205 Hours	99 Hours

[NOTE]

- ▶ Since the product's Timeshift and other implemented functions require a certain amount of HDD space allocated internally, the total size shown in the "Storage Device Manager" of Settings menu may differ from the HDD's capacity shown in the manual.





Region Code

Both products and discs are coded by region. These regional codes must match for a disc to play. If the codes do not match, the disc will not play. The Region Number for this product is displayed on the rear panel of the product.

Disc Type	Region Code	Area
Blu-ray Disc		North America, Central America, South America, Korea, Japan, Taiwan, Hong Kong and South East Asia.
		Europe, Greenland, French territories, Middle East, Africa, Australia and New Zealand.
		India, China, Russia, Central and South Asia.
DVD-VIDEO		The U.S., U.S. territories and Canada
		Europe, Japan, the Middle East, Egypt, South Africa, Greenland
		Taiwan, Korea, the Philippines, Indonesia, Hong Kong

DVD-VIDEO		Mexico, South America, Central America, Australia, New Zealand, Pacific Islands, Caribbean
		Russia, Eastern Europe, India, most of Africa, North Korea, Mongolia
		China

Logos of Discs the product can play

	
Blu-ray Disc	3D Blu-ray Disc
	
BD-LIVE	DivX
	
PAL broadcast System in U.K., France, Germany, etc.	

Getting Started

Supported Formats

Video File Support

File Extension	Container	Video Codec	Resolution	Frame rate (fps)	Bit rate (Mbps)	Audio Codec
*.avi *.mkv *.asf *.wmv *.mp4 *.3gp *.vro *.mpg *.mpeg *.ts *.tp *.trp *.mov *.flv *.vob *.svi *.m2ts *.mts *.divx	AVI MKV ASF MP4 3GP VRO VOB PS TS WebM	Divx 3.11/4.x/ 5.x/6.x MPEG4 SP/ ASP H.264 BP/ MP/HP Window Media Video v9 MPEG2 MPEG1	1920x1080	6~30	30	AC3 LPCM ADPCM (IMA, MS) AAC HE-AAC WMA DD+ MPEG(MP3) DTS Core
		VP6	640x480		4	
		SVAF			30	
		MVC	1920x1080	24/25/30	40	
*.webm	WebM	VP8		6~30	8	Vorbis

■ Limitations

- Even when the file is encoded by a supported codec listed above, a file might not be played if its content has a problem.
- Normal playback is not guaranteed if the file's container information is wrong or the file itself is corrupted.
- Files having higher Bit rate/frame rate than indicated in the table above may stutter when played back.
- Seek (skip) function is not available if the file's index table is damaged.
- When you playback a file remotely through a network connection, video playback may stutter depending on the network speed.
- Some USB/Digital camera devices may not be compatible with the product.

■ Video decoder

- Supports up to H.264 Level 4.1.
- Does not support H.264 FMO/ASO/RS, VC1 SP/MP/AP L4.

- CODECs except for MVC, VP8, VP6
 - 1) Below 1280 x 720 : 60 frames max.
 - 2) Above 1280 x 720 : 30 frames max.
 - 3) Does not support GMC 2 or higher.
- Supports SVAF Top/Bottom, Side by Side.
- Supports BD MVC Spec.
- **Audio decoder**
 - Supports WMA 10 PRO (Up to 5.1).
 - Does not support WMA lossless audio.
 - Does not support QCELP/AMR NB/WB.
 - Supports vorbis (Up to 2ch), Supports codec only in webm container.
 - Supported ADPCM IMA, MS. (MULAW, ALAW are not supported)

NOTE

- ▶ Playback of some MKV or MP4 file may not be supported depending on their video resolution and frame rate.

Supported Subtitle File Formats

	Name	File Extension
External	MPEG-4 Timed text	.txt
	SAMI	.smi
	SubRip	.srt
	SubViewer	.sub
	Micro DVD	.sub or.txt
	SubStation Alpha	.ssa
	Advanced SubStation Alpha	.ass
	Powerdivx	.psb
Internal	Xsub	AVI
	SubStation Alpha	MKV
	Advanced SubStation Alpha	MKV
	SubRip	MKV
	MPEG-4 Timed text	MP4

Music File Support

File Extension	Type	Codec
*.mp3	MPEG	MPEG1 Audio Layer 3
*.m4a *.mpa *.aac	MPEG4	AAC
*.flac	FLAC	FLAC
*.ogg	OGG	Vorbis
*.wma	WMA	WMA

Picture File Support

File Extension	Type	Resolution
*.jpg *.jpeg	JPEG	15360x8640
*.png	PNG	1920x1080
*.bmp	BMP	1920x1080
*.mpo	MPO	15360x8640

Notes on the USB connection

- Your product supports USB storage media, MP3 products, digital cameras, and USB card readers.
- Some USB/digital camera devices may not be compatible with the product.
- Your product supports the FAT16, FAT32, and NTFS files systems (read only).
- Connect USB devices directly to the product's USB port. Connecting through a USB cable may cause compatibility problems.
- Inserting more than one memory device into a multi-card reader may cause the reader to operate improperly.

Getting Started

- The product supports the PTP protocol.
- Do not disconnect a USB device during a "loading" process.
- The bigger the image resolution, the longer the image takes to display.
- This product cannot play MP3 files with DRM (Digital Rights Management) downloaded from commercial sites.
- Your product only supports video that is under 30fps (frame rate).
- Your product only supports USB Mass Storage Class (MSC) devices such as thumb drives, flash card readers and USB HDD. (HUB is not supported.)
- Certain USB HDD Devices, multi-card readers and thumb drives may not be compatible with this product.
- If some USB devices require excessive power, they may be limited by the circuit safety device.
- If playback from a USB HDD is unstable, provide additional power by plugging the HDD into a wall socket.
If the problem continues, contact the USB HDD manufacturer.
- You must remove the USB storage device safely (by performing the "Safely Remove USB" function to prevent possible damage to the USB memory).
- SAMSUNG is not responsible for any data file damage or data loss.
- Your product does not support compression file, sparse file and encryption file of NTFS.
 - Before disconnecting a USB device, please use USB Safety Removal.
 - If you don't use USB Safety Removal, your data on USB device can be corrupted or lost
 - You can repair or format a USB device on your Desktop PC. (MS-Windows OS only)

Connect a USB device before using the Timeshift and Recorded TV functions

	Do not use a USB memory stick. We do not support a USB memory stick.
	We recommend using a USB HDD with at least 5400 rpm, but a USB HDD of RAID type is not supported.

- To use the Timeshift mode or the Recorded TV function, a connected USB device must be executed the Device Format function to proper form for recording.
 - During the device formatting, do not disconnect the device while formatting is in progress. If you format the device, all files will be deleted.
 - Before formatting your device to this product, please back up your files to prevent them from damage or loss of data. SAMSUNG is not responsible for any data file damage or data loss.
- Recorded videos are DRM (digital rights managements) protected and cannot be played on a PC or other product. Note that files saved on the TV cannot be used after the main board is changed.
- At least 100MB of free space is required for recording.
- Recording will stop if the storage's free space becomes less than 50 MB.
- If the USB device has failed the Device Performance Test, the USB device must go through the Device Format and Device Performance Test again before you record with the Guide or Channel Manager.
If the device has failed the Performance Test, It cannot be used for recording.

AVCHD (Advanced Video Codec High Definition)



- This product can play back AVCHD format discs. These discs are normally recorded and used in camcorders.
- The AVCHD format is a high definition digital video camera format.
- The MPEG-4 AVC/H.264 format compresses images with greater efficiency than the conventional image compressing format.
- Some AVCHD discs use the "x.v.Color" format. This product can play back AVCHD discs that use "x.v.Color" format.
- "x.v.Color" is a trademark of Sony Corporation.
- "AVCHD" and the AVCHD logo are trademarks of Matsushita Electronic Industrial Co., Ltd. and Sony Corporation.

NOTE

- ▶ Some AVCHD format discs may not play, depending on the recording condition. AVCHD format discs need to be finalized.
- ▶ "x.v.Color" offers a wider colour range than normal DVD camcorder discs.

Accessories

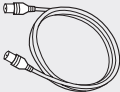
Check for the supplied accessories below.

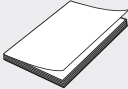
		
Audio/Video cable	RF cable for TV	Remote Control
		
Batteries for Remote Control (AAA Size)	User Manual	

Getting Started

Front Panel

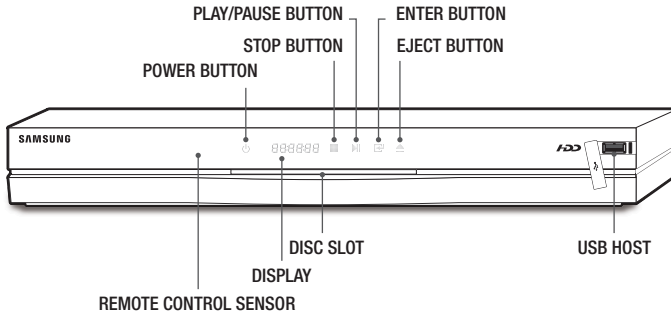

NOTE

- ▶ To upgrade the product's software through the USB Host jack, you must use a USB memory stick.
- ▶ When the product displays the Blu-ray Disc menu, you cannot start the movie by pressing the Play button on the product or the remote. To play the movie, you must select Play Movie or Start in the disc menu, and then press the  button.

Rear Panel

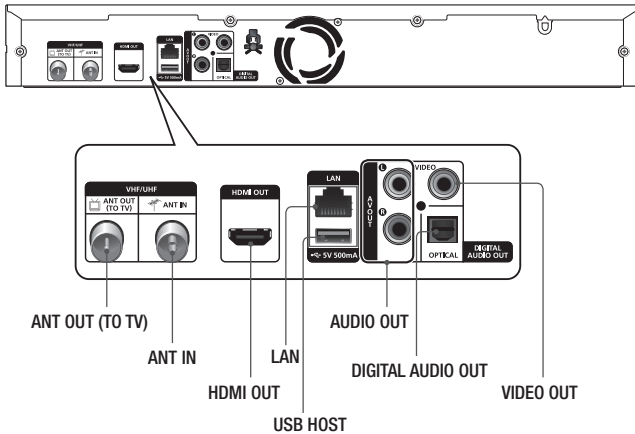

Remote Control

Tour of the Remote Control

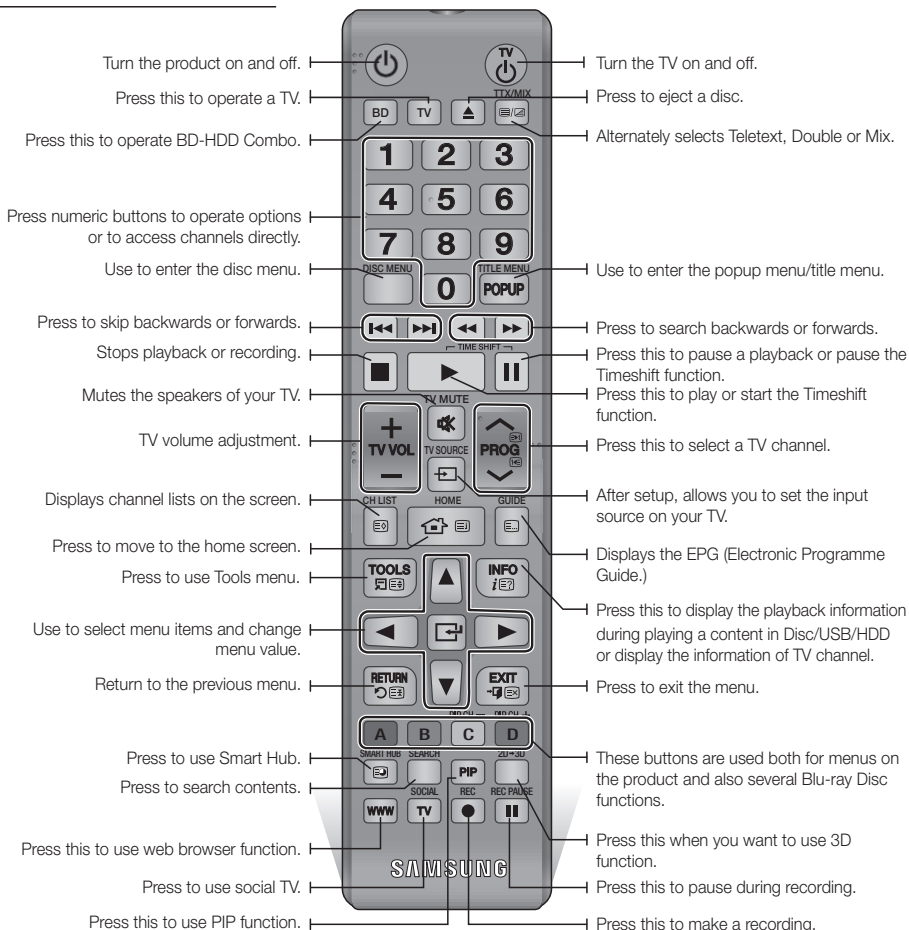

Installing batteries

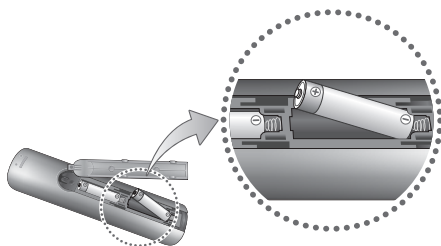

NOTE

- ▶ If the remote does not operate properly:
 - Check the polarity $+/\pm$ of the batteries.
 - Check if the batteries are drained.
 - Check if the remote sensor is blocked by obstacles.
 - Check if there is any fluorescent lighting nearby.

CAUTION

- ▶ Dispose of batteries according to local environmental regulations. Do not put them in the household trash.

Getting Started

Setting the Remote Control to Operate Your TV

■ To determine whether your television is compatible, follow the instructions below.

1. Turn your television on.
2. Point the remote control towards the television.
3. Press the **TV** button to set the TV mode.
4. Press and hold the **TV POWER** button, and then enter the two-figure code in the table to the right that corresponds to the brand of your television by pressing the appropriate number buttons.
If your television is compatible with the remote control, it will Turn off.
The remote is now programmed to operate the TV.

! NOTE I

- ▶ If several codes are listed for your television brand, try each one in turn until you find one that works.
- ▶ If you replace the remote control's batteries, you must set the brand code again.

You can control certain functions of your TV with this remote control.

Button	Function
TV POWER	Used to Turn the television on and off.
Number	Used to input number directly.
TV VOL +/-	Used to adjust the volume of the television.
TV MUTE	Used to toggle the sound on and off.
PROG (▲/▼)	Used to select the desired channel.
TV SOURCE	Used to select an external source connected to the TV.

! NOTE I

- ▶ The functions listed above will not necessarily work on all televisions. If you encounter problems, use the TV remote control.

TV Control Codes

Brand	Code	Brand	Code
SAMSUNG	TV POWER+01, +02, +03, +04, +05, +06, +07, +08, +09	NOBLEX	TV POWER+66
		NOKIA	TV POWER+74
AIWA	TV POWER+82	NORDMENDE	TV POWER+72, +73, +75
ANAM	TV POWER+10, +11, +12, +13, +14, +15, +16, +17, +18	PANASONIC	TV POWER+53, +54, +74, +75
		PHILIPS	TV POWER+06, +55, +56, +57
BANG & OLLUFSEN	TV POWER+57	PHONOLA	TV POWER+06, +56, +57
BLAUPUNKT	TV POWER+71	PIONEER	TV POWER+58, +59, +73, +74
BRANDT	TV POWER+73	RADIOLA	TV POWER+06, +56
BRIONVEGA	TV POWER+57	RADIOMARELLI	TV POWER+57
CGE	TV POWER+52	RCA	TV POWER+45, +46
CONTINENTAL EDISON	TV POWER+75	REX	TV POWER+74
DAEWOO	TV POWER+19, +20, +23, +24, +25, +26, +27, +28, +29, +30, +31, +32, +33, +34	SABA	TV POWER+57, +72, +73, +74, +75
		SALORA	TV POWER+74
EMERSON	TV POWER+64	SANYO	TV POWER+41, +42, +43, +44, +48
FERGUSON	TV POWER+73	SCHNEIDER	TV POWER+06
FINLUX	TV POWER+06, +49, +57	SELECO	TV POWER+74
FORMENTI	TV POWER+57	SHARP	TV POWER+36, +37, +38, +39, +48
FUJITSU	TV POWER+84		SIEMENS
GRADIENTE	TV POWER+70	SINGER	TV POWER+57
GRUNDIG	TV POWER+49, +52, +71	SINUDYNE	TV POWER+57
		SONY	TV POWER+35, +48
HITACHI	TV POWER+60, +72, +73, +75	TELEAVA	TV POWER+73
IMPERIAL	TV POWER+52	TELEFUNKEN	TV POWER+67, +73, +75, +76
JVC	TV POWER+61, +79	THOMSON	TV POWER+72, +73, +75
LG	TV POWER+06, +19, +20, +21, +22, +78	THOMSON ASIA	TV POWER+80, +81
LOEWE	TV POWER+06, +69	TOSHIBA	TV POWER+47, +48, +49, +50, +51, +52
LOEWE OPTA	TV POWER+06, +57	WEGA	TV POWER+57
MAGNAVOX	TV POWER+40	YOKO	TV POWER+06
METZ	TV POWER+57	ZENITH	TV POWER+63
MITSUBISHI	TV POWER+06, +48, +62, +65		
MIVAR	TV POWER+52, +77		
NEC	TV POWER+83		
NEWSAN	TV POWER+68		

Connecting to a TV with an Audio/Video cables and RF cable

1. Connect the RF cable as shown.
2. Using video/audio cables, connect the **VIDEO OUT (yellow) / AUDIO OUT (white and red)** terminals on the rear of the product to the **VIDEO IN (yellow) / AUDIO IN (white and red)** terminals of your TV.
3. Plug in the product and TV.
4. Turn on the the product and TV.

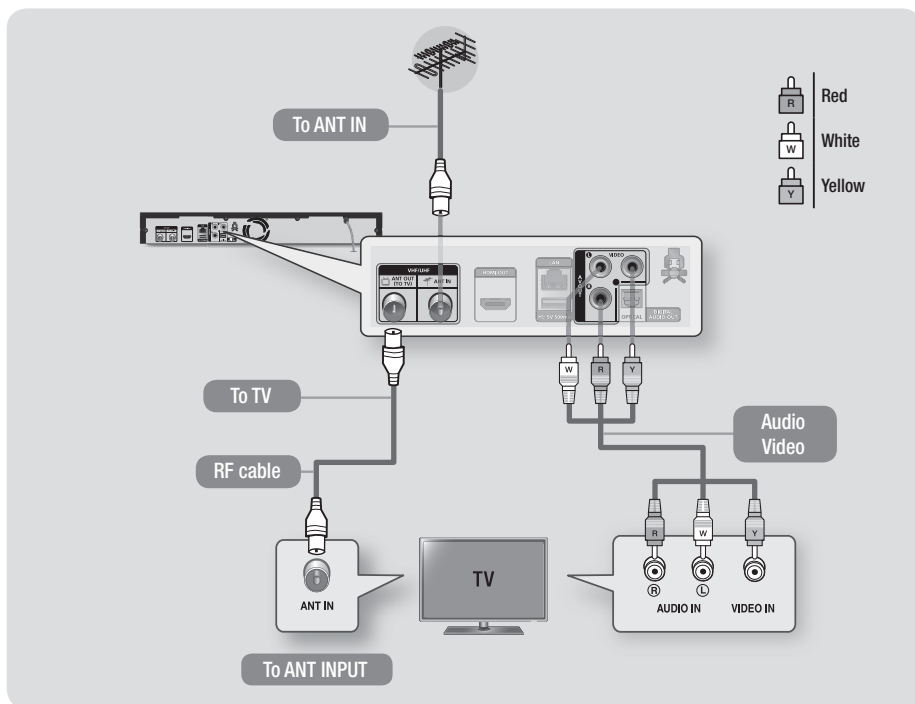

! NOTE !

- ▶ The RF cable connection of this product sends only signals of TV. You must connect the Audio/Video cables to watch output from your product.
- ▶ Noise may be generated if the audio cable is placed too close to the power cable.
- ▶ If you want to connect to an AV receiver, please refer to the AV receiver connection pages. (See page 19)
- ▶ The number and position of terminals may vary depending on your TV set. Please refer to the user manual of your TV.
- ▶ If there is only one audio input terminal on the TV, connect it to the **AUDIO OUT (Red/white)** terminal of the product.

! CAUTION !

- ▶ Do not connect the product to your TV through a VCR. Video signals fed through VCRs may be affected by copyright protection systems and the picture will be distorted on the television.

Connections

Connecting to a TV

1. Connect the product to your TV using one of the methods illustrated below.
2. Turn on the product and TV.
 - Do not connect the power cord until you have made all the other connections.
 - When you change the connections, turn off all devices before you start.
3. Press the input selector on your TV remote control until the signal from the product appears on the TV screen.

Method 1 Using an HDMI cable (not included) - Best Quality (Recommended)

Method 2 Using a Video and an Audio cable - Good Quality

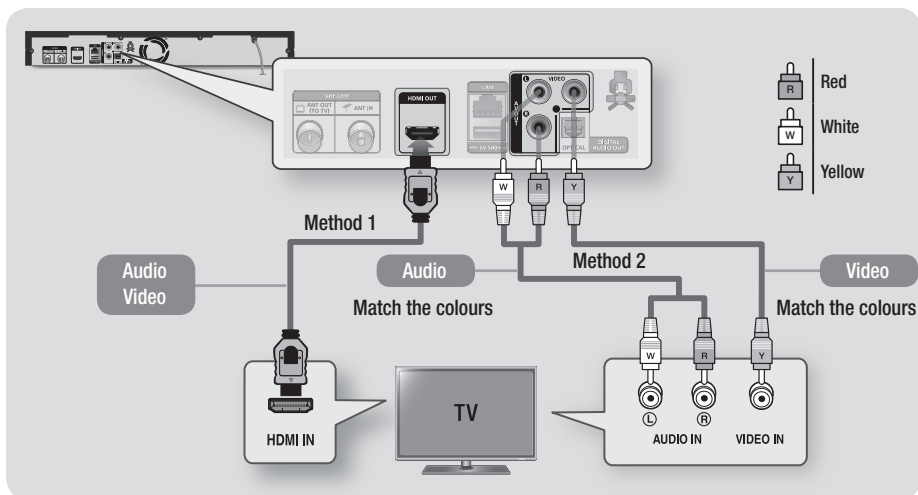

| NOTE |

- ▶ If you use an HDMI-to-DVI cable to connect to your display device, you must also connect the Digital Audio Out on the product to audio system to hear audio.
- ▶ An HDMI cable outputs digital video/audio, so you don't need to connect an audio cable.
- ▶ Depending on your TV, certain HDMI output resolutions may not work. Please refer to the user manual of your TV.
- ▶ When you connect the product to the TV using the HDMI cable for the first time or to a new TV, the HDMI output resolution will be automatically set to the highest supported by the TV.
- ▶ A long HDMI cable may cause a screen noise. If this occurs, set Deep Colour to Off in the menu.
- ▶ If the product is connected to your TV in the HDMI 720p, 1080i, or 1080p output mode, you must use a High speed (category 2) HDMI cable.
- ▶ HDMI outputs only a pure digital signal to the TV.
If your TV does not support HDCP (High-bandwidth Digital Content Protection), random noise appears on the screen.
- ▶ You must have an HDMI connection to enjoy videos with 3D technology.

Connecting to an Audio System

- You can connect the product to an audio system using one of the three methods illustrated below.
- Turn on the product, audio system and TV.
 - Do not connect the power cord until you have made all the other connections.
 - When you change the connections, turn off all devices before you start.
- Press the input selector of the connected audio system and TV until the video signal from the product appears on your TV and you hear the audio signal through your audio system.

Method 1 Connecting to an HDMI supported AV receiver

- Use an HDMI cable (not included)
- Best quality (Recommended)

Method 2 Connecting to an AV receiver with Optical input

- Use an Optical Cable (not included)
- Better quality
- You will hear sound only through the front two speakers with Digital Output set to PCM.

Method 3 Connecting to a Stereo Amplifier with an Audio Cable

- Good Quality

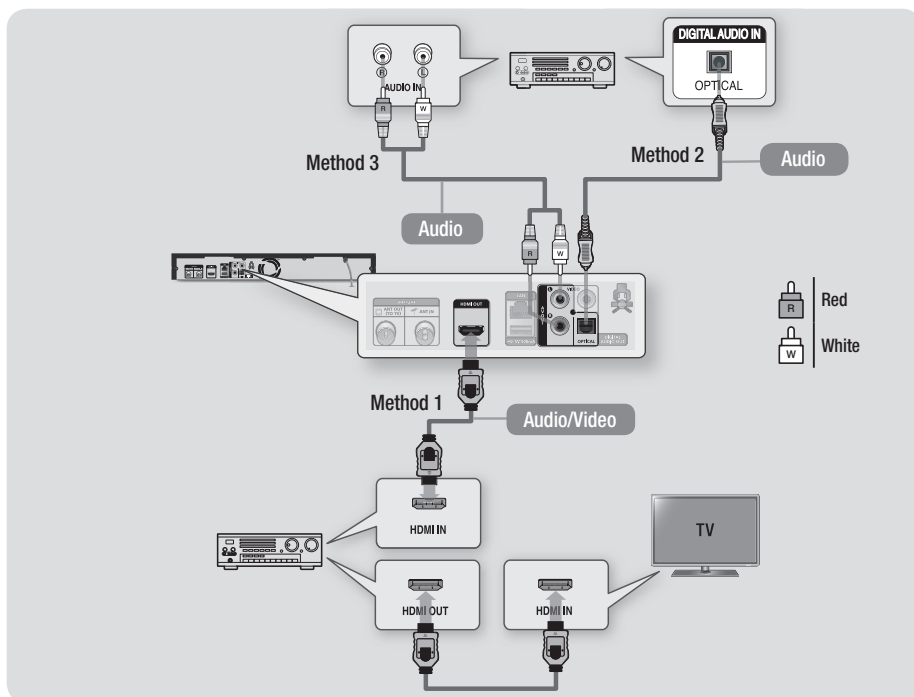

Connections

Connecting to a Network Router

You can connect your product to your network router using one of the methods illustrated below.

Wired Network

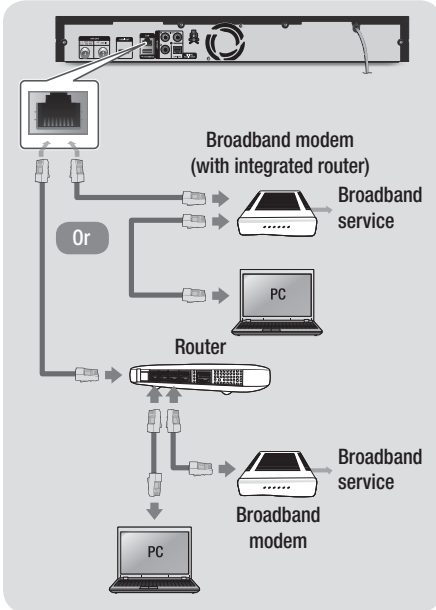

NOTE

- ▶ Internet access to Samsung's software update server may not be allowed, depending on the router you use or your ISP's policy. For more information, contact your ISP (Internet Service Provider).
- ▶ DSL users, please use a router to make a network connection.
- ▶ To use the AllShare function with your PC, you must connect your PC.

Wireless Network

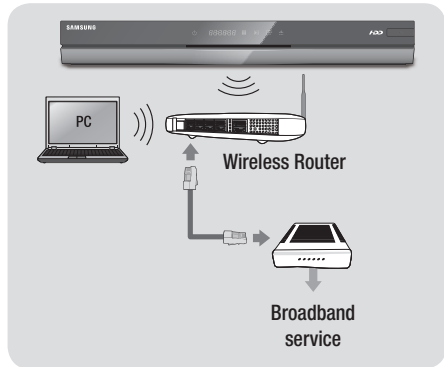

NOTE

- ▶ If the wireless router supports DHCP, your product can use a DHCP or static IP address to connect to the wireless network.
- ▶ Set your wireless router to Infrastructure mode. Ad-hoc mode is not supported.
- ▶ The product supports only the following wireless security key protocols:
 - WEP (OPEN/SHARED), WPA-PSK (TKIP/AES), WPA2-PSK (TKIP/AES)
- ▶ Select a channel on the wireless router that is not currently being used. If the channel set for the wireless router is currently being used by another device nearby, it will result in interference and communication failure.
- ▶ If you select the Pure High-throughput (Greenfield) 802.11n mode and set the Encryption type on your router or router to WEP, TKIP or TKIP-AES (WPS2Mixed), the product will not support a connection in compliance with new Wi-Fi certification specifications.
- ▶ If your router supports WPS (Wi-Fi Protected Setup), you can connect to the network via PBC (Push Button Configuration) or PIN (Personal Identification Number). WPS will automatically configure the SSID and WPA key in either mode.
- ▶ Wireless LAN, by its nature, may cause interference, depending on the operating conditions (router performance, distance, obstacles, interference by other radio devices, etc).
- ▶ To use the AllShare function with your PC, you must connect your PC.

Settings

The Setup Procedure

- The Home screen will not appear if you do not configure the initial settings.
- The OSD (On Screen Display) of this product may change after you upgrade the software version.
- The access steps may differ depending on the menu you selected.

The Setup Procedure lets you set the OSD and menu languages, configure the connection to your home network, choose the aspect ratio output (screen size and format) that is correct for your TV, and search desired channels.

NOTE

- ▶ When the product is connected to the TV for the first time, the product turns on automatically. This is normal operation.
- ▶ Password : Enter the desired 4-digit password using the number buttons.
 - Default password is set to 0000.

The Home Screen

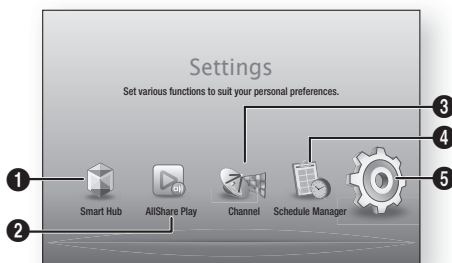

- | | |
|----------|--|
| 1 | Smart Hub : Starts Smart Hub. From Smart Hub, you can access YouTube, games, and other apps. |
| 2 | AllShare Play : Lets you select contents located on connected devices by type to view or play. You can select videos, photos, or music. |

3	Channel : Lets you configure your TV channels with features such as country and auto tune.
4	Schedule Manager : Lets you set or edit recording schedules.
5	Settings : Opens the Settings menu.

- To select an option on the Home screen:

1. Use the ◀▶ buttons to move the cursor so that it highlights your choice, and then press  button.

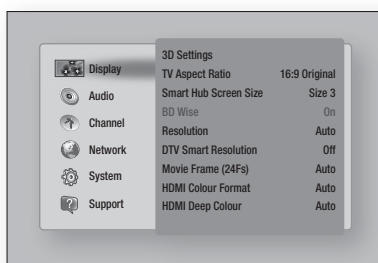

NOTE

- ▶ In the Home menu screen, it will switch to DTV Channel mode after 3 minutes. When accessing the Settings menu, the screen saver will be activated after 5 minutes.

Accessing the Settings Screen

1. Select **Settings** on the Home screen, and then press  button. The Settings screen appears.
2. To access the Settings menus, sub-menus, and options, please refer to the remote control illustration and the setting table (See pages 22~30).

Settings

Buttons on the Remote Control used for the Settings menu

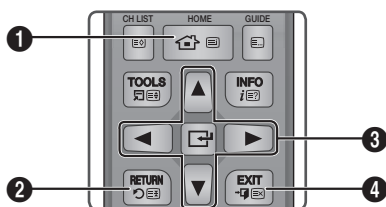

1	HOME Button : Press to move to the Home screen.
2	RETURN Button : Return to the previous menu.
3	(Enter) / DIRECTION Buttons : <ul style="list-style-type: none">• Press ▲▼◀▶ to move the cursor or select an item.• Press the  button to activate the currently selected item or confirm a setting.
4	EXIT Button : Press to exit the current menu.

Detailed Function Information

Each Settings function, menu item, and individual option is explained in detail on-screen. To view an explanation, use the ▲▼◀▶ buttons to select the function, menu item, or option. The explanation will usually appear on the screen.

A short description of each Settings function starts on the next page. Additional information on some of the functions is also in the Appendix of this manual.

Settings Menu Functions

Display	3D Settings	<p>Select whether to play a Blu-ray Disc with 3D contents in 3D Mode.</p> <ul style="list-style-type: none"> If you move to the Home or Smart Hub Home screen while in 3D mode, the product will switch to 2D automatically.
	TV Aspect Ratio	Lets you adjust the output of the product to the screen size of your TV.
	Smart Hub Screen Size	Lets you select the optimal size for the Smart Hub Screen.
	BD Wise	<p>BD Wise is Samsung's latest inter-connectivity feature. When you connect a Samsung product and a Samsung TV with BD Wise to each other via HDMI, and BD Wise is on in both the product and TV, the product outputs video at the video resolution and frame rate of the Blu-ray/DVD.</p>
	Resolution	<p>Set the output resolution of the HDMI video signal. The number indicates the number of lines of video per frame.</p> <p>The i and p indicate interlaced and progressive scan, respectively.</p> <p>The more lines, the higher quality.</p>
	DTV Smart Resolution	<p>Use this function to automatically optimise screen resolution for digital broadcasts.</p> <p> NOTE </p> <ul style="list-style-type: none"> When you use the BD wise function, this menu will not appear.
	Movie Frame (24Fs)	<p>Setting the Movie Frame (24Fs) feature to Auto lets the play adjust its HDMI output to 24 frames per second for improved picture quality.</p> <ul style="list-style-type: none"> You can enjoy the Movie Frame (24Fs) feature only on a TV supporting this frame rate. Movie Frame is only available when the product is in the HDMI 1080i or 1080p output resolution modes. <p> NOTE </p> <ul style="list-style-type: none"> When you use the BD wise function, this menu will not appear.

Settings

Display	HDMI Colour Format	Lets you set the colour space format for HDMI output to match the capabilities of the connected device (TV, monitor, etc).
	HDMI Deep Colour	Lets you output video from the HDMI OUT jack with Deep colour. Deep colour provides more accurate colour reproduction with greater colour depth.
	Progressive Mode	Lets you improve picture quality when viewing DVDs.
Audio	Digital Output	Set Digital output option suitable for your TV or AV Receiver. For more details, please refer to the digital output selection table. (See pages 72~73)
	PCM Downsampling	Set whether to use downsampling processing or not.
	Dynamic Range Control	<p>Set Dynamic Range control option for Dolby Digital, Dolby Digital Plus and Dolby TrueHD.</p> <p>✓ Auto : The Dynamic Range will be controlled automatically based on the information provided by the Dolby TrueHD Soundtrack. This setting is same with "On" for Dolby Digital and Dolby Digital Plus.</p> <p>✓ Off : You can enjoy original sound without compressing Dynamic Range of the sound.</p> <p>✓ On : The Dynamic Range is compressed appropriately by boosting low level sound and reducing extremely loud sound.</p>
	Downmixing Mode	Select Downmix method for stereo output.
	DTS Neo:6 Mode	You can enjoy multichannel sound via HDMI output even for 2 channels audio source.
	Audio Sync	<p>In some cases when the product is connected to a digital TV, the audio signal may not synchronize with the video signal. If this occurs, adjust the audio delay time to match the video signal.</p> <ul style="list-style-type: none"> You can set the audio delay time between 0 msec and 200 msec. Adjust it to the optimal setting. <p> NOTE </p> <ul style="list-style-type: none"> ▶ The audio delay time you specify may not be exact depending on the played content.

Audio

Connected Device

Choose an equipment that you have connected to this product to hear the sound in addition to your TV. Loudness of DTV Program will be adjusted according to your equipment.

✓ **AV Receiver** : Select this If you use a general AV Receiver / Home Theatre Equipment or a Television to hear sound.

✓ **AV Receiver (Offset Mode)** : Select this if your case is one of two shown below.

- If you use THX Certified AV Receiver / Home Theatre Equipment.
- In case "Digital Output" is set to "Bitstream", and If you feel the the Dolby Audio much louder than MPEG1 Layer2 Audio while watching DTV Program, select this even if your AV Receiver is not THX Certified one.

✓ **Stereo Device** : Select this if you use a Stereo Amplifier or Recording Device that support Optical Digital Audio Input as PCM format.

| NOTE |

- ▶ **For users whose TV is the only sound-producing device:**
 - If the TV does not support Dolby Digital bitstream input via HDMI, no specific setting is required.
 - If the TV supports Dolby Digital bitstream input via HDMI, set "Digital Output" to "PCM".
By doing so, the "Connected Device" will not require further setup.
- ▶ If the DTV Program you are watching is produced according to EBU R128, The Average Loudness between MPEG1 Layer2 Audio and Dolby Digital / Dolby Digital Plus audio can be reduced. If the DTV Program do not meet the EBU R128, There may be still some amount of difference of average Loudness between a TV Programs.
- ▶ Substantial number of AV Receiver / Home Theatre Device decode Dolby Digital / Dolby Digital Plus with +4dB OFFSET when compared to same encoding level of PCM input. This kind of product include both THX Certified one and also none THX Certified one.
If user select "AV Receiver(Offset mode)", the average loudness between Dolby Digital / Dolby Digital Plus audio decoded by such a product and MPEG1 Layer2 Audio decoded by this product will be similar.

Settings

Channel		
	Country	Select this to change the country. Enter the desired 4-digit password using the number buttons. Default password is set to 0000. NOTE ▶ Password : Enter the desired 4-digit password using the number buttons. - Default password is set to 0000.
	Auto Tuning	Scans for all channels with active broadcast stations and stores them. Scans for a channel automatically and stores in the product. Automatically allocated programme numbers may not correspond to actual or desired programme numbers.
	Manual Tuning	Scans for a channel manually and stores in the product. When scanning has finished, channels are updated in the channel list.
	Transfer Channel List	This function can import or export the channel map. You should connect a USB storage to use this function. ✓ Export to USB : Export channel list to USB. This function is available when USB is connected. ✓ Import from USB : Import channel list from USB.

Network	Network Settings	Configure the network connection so you can enjoy various features such as Internet services or AllShare Wi-Fi functionality, and perform Software Updates.
	Network Status	Lets you check the current network and Internet status.
	Wi-Fi Direct	Lets you connect a Wi-Fi Direct device to the product using a peer-to-peer network, without a wireless router. By Wi-Fi Direct, you may use one device to control other devices.
	Soft AP	Lets you connect other types of Wi-Fi devices to the product wirelessly. Requires that you create a security key which you must enter into the other Wi-Fi devices when you are connecting them to the network.
	AllShare Settings	<p>Manage your network connected devices and set this product's hard drive sharing options.</p> <ul style="list-style-type: none"> ✓ Device List : Set whether to allow a network connected device, like a mobile device or tablet, to share content with or control this product. ✓ Share hard drive : Set whether to share contents from this product with other network connected devices, such as mobile devices.
	Device Name	Lets you input a name for the product that will identify it on your networks.
	BD-Live Settings	<p>Set various BD-Live function. BD-Live allows you to access extra features available on some Blu-ray discs if you are connected to the Internet.</p> <ul style="list-style-type: none"> ✓ BD-Live Internet Connection : Lets you fully allow, partly allow, or prohibit a BD-Live Internet connection. ✓ Delete BD Data : Manage BD data downloaded from a BD-Live service to Blu-ray discs.
System	Setup	Sets the channels and the time when setting up this product for the first time or when resetting it.
	Clock	<p>Sets the current date and time.</p> <p>! NOTE !</p> <ul style="list-style-type: none"> ▶ If Schedule Viewing and Schedule Recording is set using GUIDE, Channel List, or Info menu, It will work based on the time information of the TV programme. <p>If you set the Clock Mode to Manual and change time manually, Schedule Viewing and Schedule Recording function can be limited or work abnormally.</p>

Settings

System	Anynet+(HDMI-CEC)	<p>Anynet+ is a convenient function that offers linked operations with other Samsung products that have the Anynet+ feature. To operate this function, connect this product to an Anynet+ Samsung TV using an HDMI cable.</p>
	Storage Device Manager	<p>Manage storage devices such as internal HDD or an external HDD connected via USB port for recording.</p> <ul style="list-style-type: none"> ✓ Format Device : Format selected device. All contents will be deleted from that device. ✓ Check Device : Check to see if there is an error with the selected device. ✓ Device Performance Test : Test the recording performance of the device. ✓ Select Device for Recording : Change the location of where you store recorded files. <p> NOTE </p> <ul style="list-style-type: none"> ▶ Since the product's Timeshift and other implemented functions require a certain amount of HDD space allocated internally, the total size shown in the "Storage Device Manager" of Settings menu may differ from the HDD's capacity shown in the manual. (See page 54)
	Device Manager	<p>You can connect a wireless USB keyboard or mouse to the USB port on the front of the product.</p> <ul style="list-style-type: none"> ✓ Keyboard settings : Lets you configure a wireless USB keyboard connected to the product. <p> NOTE </p> <ul style="list-style-type: none"> ▶ You can use the Keyboard only when a QWERTY keyboard screen or window appears in the Web Browser and Smart Hub. ✓ Mouse settings : Lets you configure a wireless USB mouse connected to the product. You can use the mouse in the product's menu in the same way you use a mouse on your PC. <p> NOTE </p> <ul style="list-style-type: none"> ▶ You can use the mouse only when a screen or window appears in the Web Browser and Smart Hub.

System

Device Manager	<ul style="list-style-type: none"> ▪ To use a mouse with the product's menu: <ol style="list-style-type: none"> 1. Connect the USB mouse to the product. 2. Click the primary button you selected in Mouse Settings. The Simple Menu appears. 3. Click the menu options you want. <p> NOTE </p> <ul style="list-style-type: none"> ▶ Depending on the model of the USB HID keyboard and mouse may not be compatible with your product. ▶ Some HID keyboard keys may not work. ▶ Wired USB keyboards are not supported. ▶ Some applications may not be supported. ▶ If a wireless HID Keyboard does not operate because of interference, move the keyboard closer to the product.
Language	<p>You can select the desired language.</p> <ul style="list-style-type: none"> • The selected language will only appear if it is supported.
Digital Text	<p>If the programme broadcasts with digital text, this feature is enabled.</p>
Security	<p>This function works in conjunction with Blu-ray Disc/DVDs that have been assigned an age rating or numeric rating that indicates the maturity level of the content. These numbers help you control the types of Blu-ray Disc/DVDs that your family can watch. When you access this function, the security screen appears. Enter the your Security password. (The default password is 0000.)</p> <ul style="list-style-type: none"> ✓ DTV Channel Lock : You can lock some channels using the Channel Lock function so that children cannot watch them. ✓ DTV Program Rating Lock : This function works in conjunction with DTV that have been assigned a rating, which helps you control the types of DTV that your family watches. Select the rating level you want to set. ✓ BD Parental Rating : Prevent playback of Blu-ray Discs with specific age ratings unless a password is entered. ✓ DVD Parental Rating : Prevent playback of DVDs with specific numerical ratings unless a password is entered. A larger number indicates that the programme is intended for adult use only. ✓ Change PIN : Change the 4-digit password used to access security functions.

Settings

System	Security	<ul style="list-style-type: none"> ▪ If you forgot your password <ol style="list-style-type: none"> 1. Press the HOME Button to move to the Home screen. 2. Remove any disc or USB storage device. 3. Press and hold the ■ button on the front panel for 5 seconds or more. All settings will revert to the factory settings. <p> NOTE </p> <ul style="list-style-type: none"> ▶ Password : Enter the desired 4-digit password using the number buttons. <ul style="list-style-type: none"> - Default password is set to 0000.
	General	<p>You can change the options listed below to match your preferences.</p> <p>✓ Advanced Music Copy : When you copy music files, information can be updated automatically. The copying time may be increased.</p> <p> NOTE </p> <ul style="list-style-type: none"> ▶ This feature is available only when the product is connected to the network <p>✓ Menu Transparency : Adjust the transparency of the menu box.</p>
	DivX® Video On Demand	View DivX® VOD Registration Codes to purchase and play DivX® VOD contents.
Support	Software Update	Software Update menu lets you upgrade your product's software to the latest version.
	Contact Samsung	Provides contact information for assistance with your product.
	Remote Management	<p>Remote management lets our Call Centre access your samsung product remotely to troubleshoot a problem. To use this program, please accept the Terms of Service Agreement.</p> <p> NOTE </p> <ul style="list-style-type: none"> ▶ To connect to remote management, please contact our call centre first. ▶ Remote management service might not be available in some countries.
	Reset	Resets all settings to their default settings except for the network and Smart Hub settings. The default security PIN is 0000.

Networks and the Internet

When you connect this product to a network, you can use network based applications and functions such as Smart Hub and BD-LIVE, and upgrade the product's software through the network connection. For more information about accessing and using Internet services, see the Network Services chapter of this manual on pages 60-62. Instructions for configuring the network connection start below.



Configuring Your Network Connection

Before you begin, contact your ISP to find out if your IP address is static or dynamic. If it is dynamic, and you have a wired or wireless network, we recommend using the Automatic configuration procedures described below.

If you are connecting to a wired network, connect the product to your router using a LAN cable before you start the configuration procedure.

If you are connecting to a wireless network, disconnect any wired network connection before you begin.

To begin configuring your network connection, follow these steps:

1. In the Home screen, select **Settings**, and then press the  button.
2. Select **Network**, and then press the  button.
3. Select **Network Settings**, and then press the  button.
4. Go to the instructions for Wired networks starting below or the instructions for Wireless networks starting on page 32.

Wired Network

□ Wired - Automatic

After following Steps 1 to 3 above:

1. Select **Start** in the Network Settings screen, and then press the  button. The product detects the wired connection, verifies the network connection and then connects to the network.





□ Wired - Manual

If you have a static IP address or the Automatic procedure does not work, you'll need to set the Network Settings values manually.

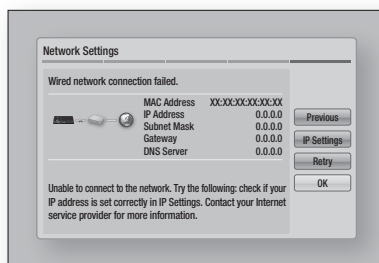
After following Steps 1 to 3 above:

1. Select **Start** in the Network Settings screen, and then press the  button. The Network Status screen appears. The product will verify the network connection.



2. Select **IP Settings** on the right of the screen, and press the  button. The IP Settings screen appears.
3. Select the **IP Mode** field, and then set it to Manual.
4. Use the number keypad on your remote to enter the Network values. Use the     buttons on the remote to move from entry field to entry field.

| NOTE |

- ▶ You can get these values from your Internet provider. You can also view these values on most Windows computers. For instructions, see "Getting the Network Settings Values." on page 32.
5. When done, highlight **OK**, and then press  button. The product verifies the network connection and then connects to the network.

Settings

< Getting the Network Settings Values >

You can view your Network Settings values on most Windows computers. To view the Network Settings values, follow these steps:

- Windows XP
 1. Right click the Network icon on the bottom right of the Windows desktop.
 2. In the pop-up menu, click Status.
 3. On the dialog that appears, click the Support tab.
 4. On the Support tab, click the Details button. The Network settings are displayed.
- Windows 7
 1. Click the Network icon on the bottom right of the Windows desktop.
 2. In the pop-up menu, click Network and Sharing Centre.
 3. On the dialog that appears, click the Local Area Connection or Wireless Network Connection depending on your network connection.
 4. On the Support tab, click the Details button. The Network settings are displayed.

| NOTE |

- ▶ Depending on your Windows version, the information may differ.

Wireless Network

You can setup a wireless network connection in three ways:

- Wireless Automatic
- Wireless Manual
- WPS(PBC)

When you configure the wireless network connection, any wireless network devices currently connected through the product will be disconnected.

| NOTE |



- ▶ Wireless network connection cannot be configured if Wired internet connection is already established.

□ Wireless (General) - Automatic

After following Steps 1 to 3 in "Configuring Your Network Connection" on page 31.

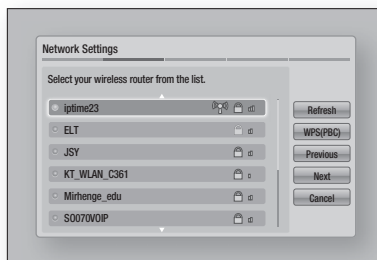
1. Select **Start** in the Network Settings screen, and then press the  button. The product searches for and then displays a list of the available networks.



2. Select the desired network, and then press the  button.
3. Select **Next**, and then press the  button again.
4. On the Security screen, enter your network's Security Code or Pass Phrase. Enter numbers directly using the number buttons on your remote control. Enter letters by selecting a letter with an arrow button, and then pressing  button.
5. When done, select **Next** at the right of the screen. The product verifies the network connection and then connects to the network.















| NOTE |

- ▶ If the desired router is not visible or if too many routers are listed, perform the following instructions. You can connect to a desired router.
 - 1) Perform up to step 2 above.
 - 2) Select **Add Network**.
 - 3) Provide a name (SSID) for the wireless router.
 - 4) Select security type.
- ▶ You should be able to find the Security Code or Pass Phrase on one of the set up screens you used to set up your router or modem.



□ Wireless (General) - Manual

If you have a static IP address or the Automatic procedure does not work, you'll need to set the Network Settings values manually.

After following Steps 1 to 3 in "Configuring Your Network Connection" on page 31.

1. Select **Start** in the Network Settings screen, and then press the  button. The product searches for and then displays a list of the available networks.
2. Select the desired network, and then press the  button.
3. Select **Next**, and then press the  button again.
4. On the Security screen, enter your network's Security Code or Pass Phrase. Enter numbers directly using the number buttons on your remote control. Enter letters by selecting a letter with the     buttons, and then pressing the  button.
5. When done, select **Next** at the right of the screen, and then press the  button.
6. The Network Status screen appears. The product attempts to verify the network connection and fails.
7. Select **IP Settings** on the right of the screen, and press the  button. The IP Settings screen appears.
8. Select the **IP Mode** field, and then set it to Manual.
9. Use the number keypad on your remote to enter the Network values. Use the     buttons on the remote to move from entry field to entry field.

! NOTE !

- ▶ You can get these values from your Internet provider. You can also view these values on most Windows computers. For instructions, see "Getting the Network Settings Values." on page 32.
10. When done, highlight **OK**, and then press  button. The Network Status screen appears. The product verifies the network connection and then connects to the network. When it is done, highlight **OK**, and then press  button.



□ WPS(PBC)

After following Steps 1 to 3 in "Configuring Your Network Connection" on page 31.

1. Select **Start** in the Network Settings screen, and then press the  button. The product searches for and then displays a list of the available networks.
2. Press the **WPS(PBC)** button on your router within two minutes. Your product automatically acquires all the network settings values it needs and connects to your network. The Network Status screen appears. The product connects to the network after the network connection is verified.

Wi-Fi Direct

The Wi-Fi Direct function allows you to connect Wi-Fi Direct devices to the product and each other using a peer-to-peer network, without a wireless router.

1. Turn on the Wi-Fi direct device and activate its Wi-Fi Direct function.
2. In the Home screen, select **Settings**, and then press the  button.
3. Select **Network**, and then press the  button.
4. Select **Wi-Fi Direct**, and then press the  button. The Wi-Fi Direct devices that you can connect appear.

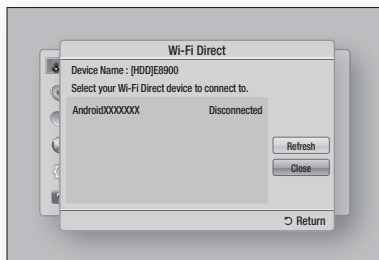



Settings

5. You have three ways to complete the Wi-Fi connection:
 - Through the Wi-Fi device.
 - Through the product using PBC.
 - Through the product using a PIN.Each is covered below.



Through the Wi-Fi Device

1. On the Wi-Fi device, follow the procedure on the device for connecting to another Wi-Fi Direct device. See the device's user manual for instructions.
2. When you have completed the procedure, you should see a pop-up on your TV screen saying that a device that supports Wi-Fi Direct has requested to connect. Select **OK**, and then press the  button to accept.
3. The Connecting pop-up appears, followed by the Connected pop-up. When it closes, you should see the device listed on the Wi-Fi Direct screen as connected.

Through the Product Using PBC

1. Select the Wi-Fi Direct device you want to connect to this product, and then press the  button. The PBC/PIN pop up appears.
2. Select **PBC**, and then press the  button. The PBC pop-up appears.
3. Press the **PBC** button on the Wi-Fi Direct device within 2 minutes.
4. The Connecting pop-up appears, followed by the Connected pop-up. When it closes, you should see the device listed on the Wi-Fi Direct screen as connected.

Through the Product Using a PIN

1. Select the Wi-Fi Direct device you want to connect to this product, and then press the  button. The PBC/PIN pop up appears.
2. Select **PIN**, and then press the  button. The PIN pop-up appears.

3. Note the PIN code in the pop-up, and then enter it into the appropriate field in the Wi-Fi Direct device you want to connect.
4. The Connecting pop-up appears, followed by the Connected pop-up. When it closes, you should see the device listed on the Wi-Fi Direct screen as connected.





| NOTE |

- ▶ The wired or wireless network connection will be disconnected when you use the Wi-Fi Direct function.
- ▶ Some Wi-Fi Direct devices may not support the AllShare function if connected via Wi-Fi Direct. If this is the case, it is advisable to change the network connection method between devices.











Soft AP

This product provides a function as a wireless Access Point.

Soft AP lets you connect other Wi-Fi devices to your network wirelessly through the product. It requires that you create a security key which you must enter into the other Wi-Fi devices when you are connecting them to the network.

1. In the Home screen, select **Settings**, and then press the  button.
2. Select **Network**, and then press the  button.
3. Select **Soft AP**, and then press the  button.
4. Select **On** or **Off**, and then press the  button.







< To Set the Soft AP Security Key >

1. On the Soft AP screen, select **Security Key**, and then press the  button. The Security Key screen appears.
2. On the Security key screen, enter a security key. Enter numbers directly using the number buttons on your remote control. Enter letters by selecting a letter with the     buttons, and then pressing the  button.
3. When done, use the     buttons to move to **DONE** at the bottom of the screen, and then press the  button.

When you connect a Wi-Fi device through the connection procedure on the device, you must enter the security key you created here into the appropriate field.

AllShare Settings

The AllShare Settings screen lists your network connected AllShare devices and their IP addresses. Through this screen, you can allow a device to access the product, deny access, or delete the device from the AllShare list.

1. In the Home screen, select **Settings**, and then press the  button.
2. Select **Network**, and then press the  button.
3. Select **AllShare Settings**, and then press the  button.
4. Select **Device List**, and then press the  button. In the Device List, select a device, and then press the  button. The AllShare Settings pop-up appears.
5. Select **Allow**, **Deny**, or **Delete from List**, and then press the  button.

The AllShare Settings screen only displays devices if you have established network connections to AllShare devices. For more information about AllShare networked devices, see page 41.

NOTE

- ▶ The "Share hard drive" option should be set to **On** to share the contents through AllShare function.





Device Name

Lets you input a name for the product that will identify it on your networks.

Upgrading Software

The Software Update menu allows you to upgrade the product's software for performance improvements or additional services.

- Never turn the product off or back on manually during the update process.

1. In the Home screen, select the **Settings**, and then press the  button.
2. Select **Support**, and then press the  button.
3. Select **Software Update**, and then press the  button.
4. Select one of the following methods:
 - Online
 - By Channel
 - By USB
 - By Disc
 - By Downloaded
 - Standby Mode Upgrade
5. Press the  button.

NOTE

- ▶ The upgrade is complete when the product turns off, and then turns on again by itself.
- ▶ Samsung Electronics shall takes no legal responsibility for product malfunction caused by an unstable Internet connection or consumer negligence during a Software update.
- ▶ If you want to cancel the upgrade while the upgrade software is downloading, press the  button.

Online

Your product must be connected to the Internet to use the Online function.

1. Select **Online**, and then press the  button. The Connecting to Server message appears.
2. If there is a download available, the Download pop-up appears with a progress bar and the download starts.

Settings

3. When the download is complete, the Upgrade Query window appears with three choices: Upgrade Now, Upgrade Later, or Don't Upgrade.
4. If you select Upgrade Now, the product upgrades the software, turns off, and then turns on automatically.
5. If you do not make a selection in one minute or select Upgrade Later, the product stores the new upgrade software. You can upgrade the software later using the By Downloaded function.
6. If you select Don't Upgrade, the product cancels the upgrade.

By Channel

Upgrade software using the broadcasting signal.

By USB

1. Visit www.samsung.com.
2. Click **SUPPORT** on the top right of the page.
3. Enter the product's model number into the search field, and then click **Find Product**.
4. Click **Get downloads** in the centre of the page below the Downloads header.
5. Click **Firmware** in the centre of the page.
6. Click the **ZIP** icon in the File column on the right side of the page.
7. Click **OK** in the pop-up that appears to download and save the firmware file to your PC.
8. Unzip the zip archive to your computer. You should have a single folder with the same name as the zip file.
9. Copy the folder to a USB flash drive.
10. Make sure no disc is inserted in the product, and then insert the USB flash drive into the USB port of the product.
11. In the product's menu, go to Settings > Support > Software Update.
12. Select **By USB**.

| NOTE |

- ▶ There should be no disc in the product when you upgrade the software using the USB Host jack.
- ▶ When the Software update is done, check the software details in the software update menu.
- ▶ Do not turn off the product during the software update. It may cause the product to malfunction.
- ▶ Software updates using the USB Host jack must be performed with a USB flash memory stick only.

By Disc

1. Follow Steps 1 through 7 in **By USB**.
2. Unzip the zip archive to your computer. You should have a single folder with the same name as the zip file.
3. Write the folder onto a disc. We recommend a CD-R or DVD-R.
4. Finalize the disc before you remove it from your computer.
5. Insert the disc into the product.
6. In the product's menu, go to Settings > Support > Software update.
7. Select **By Disc**.

| NOTE |

- ▶ When the system upgrade is done, check the software details in the software update menu.
- ▶ Do not turn off the product during the Software update. It may cause the product malfunction.

By Downloaded

The By Downloaded option lets you upgrade using a file the product downloaded earlier but you decided not to install immediately or a file downloaded by the product in Standby Mode.

1. If upgrade software has been downloaded, you will see the software version number to the right of By Downloaded.
2. Select **By Downloaded**, and then press the  button.
3. The product displays a message asking if you want to upgrade. Select **Yes**. The product begins the upgrade.
4. When the update is complete, the product turns off automatically, and then turns on.

| NOTE |

- ▶ When the system upgrade is done, check the software details in the software update menu.
- ▶ Do not turn off the product during the software update. It may cause the product to malfunction.

Standby Mode Upgrade

You can set the Standby Mode Upgrade function so that the product downloads new upgrade software when it is in Standby mode.

In Standby mode, the product is off, but its Internet connection is active. This allows the product to download upgrade software automatically, when you are not using it.

1. Press the ▲▼ buttons to select **Standby Mode Upgrade**, and then press the  button.
2. Select the desired time.
If you select the desired time, the upgrade is automatically performed time.

| NOTE |

- ▶ To use Standby Mode Upgrade function, your product must be connected to the Internet.

Media Play

Insert a Disc to the Disc tray

1. Place a disc gently into the disc slot with the disc's label facing up.
Playback starts automatically.

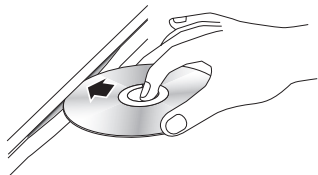

2. If playback does not start automatically, please refer to "Accessing the AllShare Play Screen" on pages 38~39.

| NOTE |

- ▶ In TV view mode, the button will function as Timeshift rather than its original function, playback even if there is a disc inserted.
- ▶ In Home screen, the button will function as playback of multimedia content in the disc.

Insert a USB or Mobile Phone to the USB port

You can play multimedia files located on a USB or mobile phone.

To play contents located on your mobile phone, the product and mobile phone should be connected with USB cable. If your mobile phone is DLNA compatible, you can play contents without connecting USB cable. (See pages 39~41)

1. Connect the USB or mobile phone to the USB port on the front panel of the product.

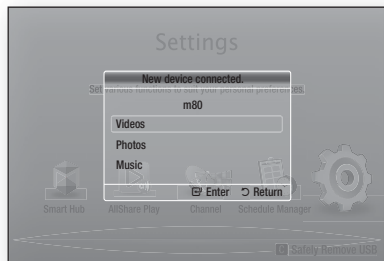

2. Select Videos, Photos, or Music, and then press the button.
Depending how the contents are arranged, you will see either folders, individual files, or both.
3. Select the desired files.
4. Press the **RETURN** button to exit a folder or to return to Home screen screen.

| NOTE |

- ▶ You must remove the USB storage device safely (by Performing the "Safely Remove USB" function) in order to prevent possible damage to the USB memory.
- ▶ If you insert a disc when playing a USB storage device, the device mode changes to "DVD or CD" automatically.

Accessing the AllShare Play Screen

You can play content located on a disc or USB device through the AllShare screen

1. Select **AllShare Play** on the Home screen, and then press the button.
2. Select the desired contents, and then select the desired device.



1	<p>My List : Lets you check a recently played or updated files.</p> <ul style="list-style-type: none"> • Recently Played Shows the list of contents viewed recently. <ul style="list-style-type: none"> - If selected file is deleted or the storage device containing selected file was removed, a message of the selected file is unavailable will appear. - Shows contents in the order of time, based on the device's system time. - Lists up to 48 items. • What's new It shows a new contents. • Playlist You can build your own playlist grouping desired contents. <ul style="list-style-type: none"> - You can store up to 12 playlists. - Up to 100 files can be listed into each playlist. - If a playlist is created as music playlist, only music files can be added to the list.
2	<p>Contents Type : Lets you select a desired contents.</p>
3	<p>Device Type : Lets you select a desired connected device.</p>
4	<p>Displays the coloured buttons on your remote that you can press to access or perform functions.</p>

| NOTE |



- ▶ **To make a playlist**
Select a desired contents (Videos, Photos or Music), and then highlight the desired files. Press the **TOOLS** button, and then select **Add to Playlist**.
- ▶ The video files played via DLNA will be listed in My List only when the network connection has been established.
- ▶ Blu-ray/DVD/CD disk contents will not be listed in My List.

Using the AllShare Play Function

AllShare Play lets you play Videos, Photos, or Music located in your PC or your DLNA compatible devices, Facebook, SugarSync and Family Story on the BD-HDD Combo with network connection.

To use AllShare with your PC, you must install AllShare software on your PC.

| NOTE |

- ▶ Once the connection is established, you can not only play the video content but also transfer data between devices using the Allshare feature.
For more information, refer to pages 46~48.
1. Connect the BD-HDD Combo and DLNA compatible products to the same network .
 2. Select **AllShare Play** in the Home screen, and then press the  button.
 3. Select the connected DLNA compatible product name, and then press the  button.



4. Select desired file on the screen, and then press the  button.
 - **HDD** : You can play content that is stored in the HDD.
 - **Disc** : You can play content that is stored in the disc.
 - **USB** : You can play content that is stored in the USB memory.

Media Play

- **Camera** : You can play content that is stored in the connected camera.
 - **DLNA** : You can play content that is stored in the connected storage device.
 - **Picasa** : You can play content that is stored in the Picasa.
 - **SugarSync** : You can play content in the Cloud service that you are registered with.
 - **Family Story** : You can play content that is stored in Family Story.
 - **Facebook** : You can play content that is stored in the facebook.
5. On the Download Centre page, click the Software tab.
 6. On the software tab, click the File icon on the right side of the AllShare line.
 7. In the pop-up that appears, click Save File.
 8. Find the AllShare install file on your disk, and then double click the file.
 9. In the pop-up that appears, click Run, and then follow the directions that appear on your screen.

| NOTE |

- ▶ To enable some of the services, you should have been logged in with the respective user account for that particular service.
Once you have logged in to Smart Hub with a registered Samsung account, you can add an account with that particular service by selecting Account Manager.
- ▶ Application may require to be installed through Samsung Apps for services not appearing on the factory default.
- ▶ Some services may require logging in, and you can manage your login account on Smart Hub.
- ▶ Some services may require creating account and subscription to a website of corresponding service.

To download the AllShare software

To use AllShare with your PC, you must install AllShare software on your PC.
You can download the PC software and get detailed instructions for using AllShare from the Samsung.com website.

1. Go to www.samsung.com.
2. Click Support at the top of the page.
3. On the Support page, enter the model number of your product into the Model Number field, and then press the  button.
4. On the page that appears, click Get downloads on the left side under Downloads. The Download Centre appears.

Playing content located in your PC on the BD-HDD Combo

You can view shared files of your computer on your BD-HDD Combo.

You can get detailed instructions for using AllShare from the Samsung.com website.

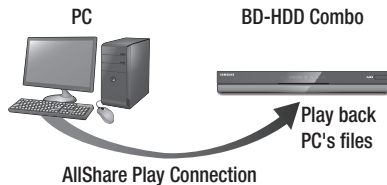

Playing content located in your Mobile device on the BD-HDD Combo

You can view shared files of your Mobile device to your BD-HDD Combo.

You can get detailed instructions for using AllShare from the Samsung.com website.

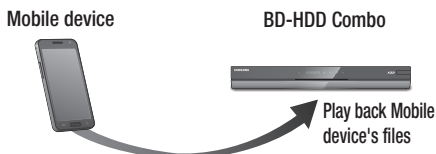

Controlling with your mobile device

Use your mobile device to view files stored in your computer, played by BD-HDD Combo. (Only available with Samsung mobile devices supporting AllShare functionality.)

You can get detailed instructions for using AllShare from the Samsung.com website.

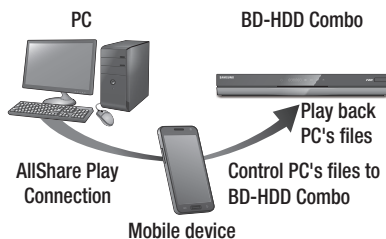

NOTE

- Once the connection is established, you can not only play the video content but also transfer data between devices using the Allshare feature. For more information, refer to pages 46~48.

Controlling Video Playback

You can control the playback of video content located on a Disc, USB, mobile device or PC. Depending on the disc or contents, some of the functions described in this manual may not be available.

Buttons on the Remote Control used for Video Playback



■ Playback related buttons

The player does not play sound in Search, Slow or Step mode.

- To return to normal speed playback, press the button.

button	Starts playback.
button	Stops playback.
button	Pauses playback.
Fast Motion Play	During playback, press the or button. Each time you press the or button, the playback speed will change.
Slow Motion Play	In pause mode, press the button. Each time you press the button, the playback speed will change.
Step Motion Play	In pause mode, press the button. Each time you press the button, a new frame appears.
Skip Motion Play	During playback, press the or button. Each time you press or button, the disc moves to the previous or next chapter or file. NOTE ▶ If you press the button after three seconds of playback, the current chapter or file will be replayed from the beginning. But, if you press the button within three seconds after playback starts, the previous chapter or file will be played.





■ Using the disc menu, title menu, popup menu, and title list

DISC MENU button	During playback, press this button to display the Disc menu. NOTE ▶ Some discs may not support this button.
TITLE MENU button	During playback, press this button to display the Title menu. • If your disc has a playlist, press the GREEN (B) button to go to the playlist.
POPUP MENU button	During playback, press this button to display the Popup menu.

Using the Tools Menu

During playback, press the **TOOLS** button.

Play from the Beginning	Select to return to the beginning of the movie, and then press the button.
Title Search	If there is more than one movie on the disc or device, select to start a different title. 1. Select Title Search, and then press the button. 2. Use the buttons to select a title, and then press the button.
Chapter Search	Select to play the chapter of your choice. 1. Select Chapter Search, and then press the button. 2. Use the buttons to select a chapter, and then press the button.

Time Search	<p>Select to play the movie from a selected time point.</p> <ol style="list-style-type: none"> 1. Select Time Search, and then press the  button. 2. Using the number buttons, enter the time point you want to go to, and then press the  button. <p>I NOTE I</p> <ul style="list-style-type: none"> ▶ You can also use the ◀▶ buttons to advance or rewind the movie. The movie advances or rewinds one minute each time you press the ◀▶ buttons. 	Picture Mode	<p>Select to set the picture mode.</p> <ul style="list-style-type: none"> - Dynamic : Increases sharpness and brightness. - Standard : Choose this setting for most viewing applications. - Movie : The best setting for watching movies. - User : Lets you adjust the sharpness and noise reduction function respectively. <p>I NOTE I</p> <ul style="list-style-type: none"> ▶ When you use the BD wise function, this menu will not appear.
Repeat Mode	<p>Select to repeat a title, chapter, or specific section.</p> <ul style="list-style-type: none"> - Off : Select to return to normal playback. - Title : Choose to repeat a selected title. - Chapter : Choose to repeat a specific chapter. - Repeat A-B : Choose to repeat a specific section. <ol style="list-style-type: none"> 1. Press the ▲▼ buttons to select repeat A-B, and then press the  button. 2. Press the  button at the point where you want repeat play to start (A). Let the movie play. 3. Press the  button at the point where you want repeat play to stop (B). <p>I NOTE I</p> <ul style="list-style-type: none"> ▶ You must set point (B) at least 5 seconds of playing time after point (A). 	Audio	<p>Select to set the desired audio language.</p>
		Subtitle	<p>Select to set the desired subtitle language.</p> <ul style="list-style-type: none"> - You can also operate this function by pressing the SUBTITLE button on the remote control.
		Angle	<p>Select to view a scene from another angle. The Angle option displays the number of angles available to view. When a Blu-ray Disc/DVD contains multiple angles of a particular scene, you can change angle.</p>
		BONUSVIEW Video	<p>Select to set the desired bonusview option.</p>
		BONUSVIEW Audio	
		Go to Videos List	<p>Select to go to the list of videos on the current media.</p>
Full Screen	<p>Select to change the full screen size.</p>	Information	<p>Select to view video file information.</p>

I NOTE I

- ▶ Depending on the disc or storage device, the Tools menu may differ. See pages 46~48 for additional options.
- ▶ Video files with high bit rates of 20Mbps or more strain the player's capabilities and may stop playing during playback.

Controlling Music Playback

You can control the playback of music content located on a Disc, USB, mobile device or PC.

Buttons on the Remote Control used for Music Playback

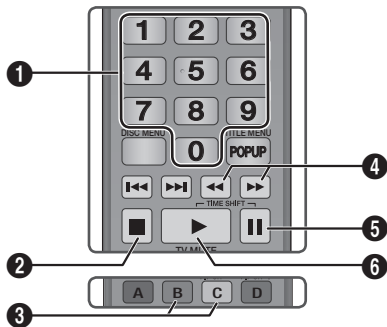

1	NUMBER buttons : Press the number of a track. The selected track is played.
2	■ button : Stops a track.
3	Skip : During playback, press the GREEN (B) or YELLOW (C) button to move to the previous or next page of the playlist.
4	Fast Play (Audio CD (CD-DA) only) During playback, press the ◀▶ or ▶▶ button. Each time you press the ◀▶ or ▶▶ button, the playback speed will change.
5	⏸ button : Pauses a track.
6	▶ button : Plays the currently selected track.

Using the Tools Menu

During playback, press the **TOOLS** button.

View	See pages 46~48.
Folder view	See pages 46~48.
Title	See pages 46~48.
Artist	See pages 46~48.
Album	See pages 46~48.



Genre	See pages 46~48.
Play selection	See pages 46~48.
Go to Playlist	See pages 46~48.
Rip	The Ripping function converts CD audio to the mp3 format and saves the converted files on a USB device connected to the player. See Ripping on page 45.
Information	Select to see the (Contents) information: File size, date created, etc.

NOTE

- ▶ Depending on the disc or storage device, the Tools menu may differ. See pages 46~48 for additional options.

Repeating Tracks on an Audio CD

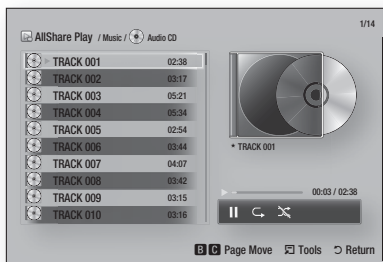

You can set the product to repeat tracks on an audio CD (CD-DA/MP3).

1. During playback, use the **▶** button to select  in the lower right corner of the screen, and then press the  button.
2. Use the **▲▼** to select the repeat mode you want - Off, One Song, or All - and then press the  button.







Shuffling Tracks on an Audio CD



You can set the product to play tracks on an audio CD (CD-DA/MP3) at random.

1. During playback, use the **▶** button to select  in the lower right corner of the screen, and then press the  button.
2. Use the **▲▼** to set the Shuffle mode **On** or **Off**, and then press the  button.







Creating a Playlist from a CD

1. With the Playback screen displayed, press the **TOOLS** button. The Tools menu appears.
2. Use the ▲▼ buttons to select **Play selection**, and then press the  button. The Play selection screen appears.
3. Use the ▲▼ buttons to select a track, and then press the  button. A check appears to the left of the track.
4. Repeat Step 3 to select and check additional tracks.
5. To remove a track from the list, move to the track, and then press the  button again. The check on the track is removed.
6. When done, press the ► button to select **Play**, and then press the  button. The Music Playback screen reappears listing only the tracks you checked. The selected tracks play automatically.

| NOTE |

- ▶ You can create a playlist with up to 99 tracks on Audio CDs (CD-DA).
- ▶ If you have created a playlist, Play selection is replaced by Edit Playlist on the Tools menu.
- ▶ On the Play selection screen, you can also choose Select All, Deselect All, and Cancel.
 - Use Select All to select all tracks. This cancels your individual track selections. When you press the **RETURN** button on your remote or select ► button, and then press the  button, all tracks will appear on the Music Playback screen, and the product will begin to play all tracks from Track 001.
 - Use Deselect All to deselect all selected tracks at once. Then, select individual tracks or use Select All to select all the tracks, and then press the **RETURN** button on your remote or select ► button, and then press the  button. If you do not use Select All or select individual tracks, the Playlist will not change.
 - Cancel cancels any changes you made on the Play Select screen. When you return to the Playback screen, the Playlist will be unchanged.

Ripping

1. Insert a USB device into the USB jack on the rear of the product.
2. With the Playback screen displayed, press the **TOOLS** button. The Tools menu appears.
3. Use the ▲▼ buttons to select Rip, and then press the  button. The Rip screen appears.
4. Use the ▲▼ buttons to select a track, and then press the  button. A check appears to the left of the track.
5. Repeat Step 3 to select and check additional tracks.
6. To remove a track from the list, move to the track, and then press the  button again. The check on the track is removed.
7. When done, press the ► button to select Rip, and then press the  button. The Rip pop-up appears.
8. Press the  button to begin the ripping process. The Ripping Completion Bar popup appears.
9. When ripping is complete, the "Ripping is completed" message appears. Press the  button.
10. Press the **RETURN** button to go back to the Playback screen.

| NOTE |

- ▶ This function is not available with DTS Audio CD.
- ▶ This function may not be supported by some discs.
- ▶ This function will be encoded to the .mp3 format at 192kbps.

AMG (All Media Guide) function

You can use AMG function to display the information of an Audio CD (CD-DA).

1. Insert an Audio CD (CD-DA). If your disc has CD information, pop-up screen will be displayed.
2. Press the  button. The CD information will be displayed and the first track will be played automatically.

| NOTE |

- ▶ When the product is disconnected from the network, it may not retrieve the CD information from the Audio CD (CD-DA).

Playing Photo Contents

You can play photo contents located on a Disc, USB, mobile device or PC.

Using the Tools Menu

During playback, press the **TOOLS** button.

Go to Photos List	Select to go to the list of photos on the current media.
Start Slide Show	Select to start the slide show.
Slide Show Speed	Select to set a slide show s speed.
Slide Show Effect	Select to set a slide show s special effects.
Background Music On	Select to listen to music while viewing a slide show.
Background Music Setting	Select to set the background music setting.
Picture Mode	<p>Select to set the picture settings.</p> <ul style="list-style-type: none"> - Dynamic : Choose to increase Sharpness. - Standard : Choose for most viewing applications. - Movie : This is the best setting for watching movies. - User : Lets you adjust the sharpness and noise reduction function respectively. <p>I NOTE I</p> <ul style="list-style-type: none"> ▶ When you use the BD wise function, this menu will not appear.
Zoom	Select to enlarge the current picture. (Enlarge up to 4 times)
Rotate	Select to rotate the picture. (This will rotate the picture either clockwise or counter clockwise.)
Play selection	See pages 46~48
Login/Out	See pages 46~48.
Information	Shows the picture information.





I NOTE I







- ▶ Depending on the disc or storage device, the Tools menu may differ. All options may not be displayed.
- ▶ To enable the background music function, the photo file must be in the same storage media as the music file. However, the sound quality can be affected by the bit rate of the MP3 file, the size of the photo, and the encoding method.
- ▶ You can t enlarge the subtitle and PG graphic in the full screen mode.

Using the Tools Menu when a file is highlighted







When a file is highlighted, press the **TOOLS** button.

View	Select to access the sort options: Artist, Genre, Monthly, Latest Date, etc. The sort options that appear depend on the storage and media type.
Folder view	Appears in the View function screen. Select to display the folders on the storage device.
Title	Appears on the View function screen. Select to sort all photo or video files on a storage device by title.
Artist	Appears on the View function screen. Select Artist to sort and then display all music tracks on a storage device by artist.
Album	Appears on the View function screen. Select Album to sort and then display all music tracks on a storage device by album.
Genre	Appears on the View function screen. Select Genre to sort and then display all music tracks on a storage device by genre.

Latest Date	Appears on the View function screen. Select to sort and then display all photo or video files on a storage device from the latest to earliest date.
Earliest Date	Appears on the View function screen. Select to sort and then display all photo or video files on a storage device from the earliest to latest date.
Monthly	Appears on the View function screen. Select to sort all photo or video files on a storage device by the month created.
Play selection	<p>Play selection lets you select specific music, video, and photo files to play. It works essentially the same for all media. The example below is for photos.</p> <ol style="list-style-type: none"> 1. On the selection screen, use the ▲▼◀▶ buttons to select a photo you want to view, and then press the  button. A check mark appears to the left of the picture. 2. Repeat Step 1 for each photo you want to view. 3. To de-select a photo, highlight it, and then press the  button. 4. When done, use the ◀▶ buttons to select Play, and then press the  button. A slide show containing the photos you selected begins. 5. To pause the slide show, press the  button once. To restart the slide show, press the  button again. 6. To stop the slide show, press the RETURN button. <p> NOTE </p> <ul style="list-style-type: none"> ▶ After the slide show begins, you can control the slide show by pressing the TOOLS button and displaying the Slide Show menu. See "Using the Tools Menu" page 46.

Send	<p>Select Send to upload selected files to Picasa, Facebook, SugarSync or Family Story.</p> <p>To use Send, you need to establish an account with the on-line site, and then log in using the Log In function.</p> <ol style="list-style-type: none"> 1. Use the ▲▼◀▶ buttons to select a file, and then press the  button. 2. Repeat for each track or file you want to upload. <p> NOTE </p> <ul style="list-style-type: none"> ▶ You can also move to Select All on the right, and then press the  button to select all tracks or files. <ol style="list-style-type: none"> 3. Select Send on the right side, and then press the  button. 4. Use the ▲▼ buttons to select the on line site you want to upload the files or tracks to, and then press the  button.
Login / Out	The Log In/Out function lets you log in to your online Samsung account.
Add to Playlist	<p>Select to create a playlist or add files or tracks to a playlist.</p> <ol style="list-style-type: none"> 1. Use the ▲▼◀▶ buttons to highlight a track or file, and then press the  button. 2. Repeat for each track or file you want to add. 3. Select Add to Playlist on the right, and then press the  button. 4. On the screen that appears, perform one of the following actions:

Media Play

<p>Add to Playlist (continued)</p>	<ul style="list-style-type: none"> • Select the Playlist to which you want to add the tracks or files and then press  button. • Select Create New, and then press the  button. On the keyboard pop-up that appears, create a name for the new playlist. Enter numbers using the numbers on the remote. Enter letters by using the ▲▼◀▶ buttons to move the cursor, and then pressing the  button. When finished, move to DONE at the bottom of the screen, and then press the  button.
<p>Delete (Playlist)</p>	<p>Depending on the screen you are viewing, select Delete to erase a file from erasable media (such as a USB device) or to delete a playlist.</p>
<p>Edit Playlist</p>	<p>Select Edit Playlist to remove files or tracks from an existing playlist. The storage device containing the playlist must be inserted into or attached to the player.</p> <ol style="list-style-type: none"> 1. Use the ▲▼◀▶ buttons to select a file, and then press the  button. 2. Repeat for each track or file you want to remove. <p>NOTE</p> <ul style="list-style-type: none"> ▶ You can also move to Select All on the right, and then press the  button to select all tracks or files. <ol style="list-style-type: none"> 3. Select Remove on the right side, and then press the  button.
<p>Play Current Group</p>	<p>After you have sorted by Artist, Genre, Album, Title, Latest Date, Earliest Date, or Monthly, select a group that is the result of the sort (for example, all pictures taken in August), and then select Play Current Group to play or view the files in that group only.</p>

<p>Go to Playlist</p>	<p>Select to go to the Playlist section of the Main AllShare screen.</p>
<p>Encoding</p>	<p>Encoding - which changes by language or by geographical area - modifies how the player sorts, arranges, and presents files or tracks, displays dates, etc. Select Encoding to change the encoding to match your language or geographical area.</p>
<p>Information</p>	<p>Displays media file and content information.</p>

NOTE

- ▶ Depending on the disc or storage device, the Tools menu may differ. All options may not be displayed.

DTV Functions

Watching TV Channels

After Tuning is completed, you can watch TV channel.

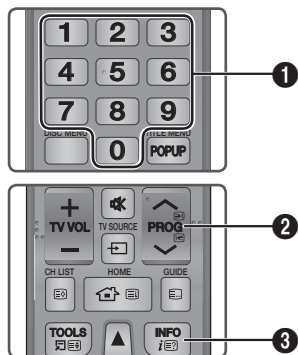

1	NUMBER buttons : To move TV channel directly, press the channel numbers of desired TV channel.
2	PROG buttons : Press this button to change TV channels.
3	INFO buttons : Press this button to display detailed information of selected channel.

NOTE I

- ▶ If you want to watch TV while you are playing Blu-ray Disc/DVD/CD contents with AllShare, or Internet contents via Smart Hub, press the **EXIT** button on your remote control. With the **EXIT** button, you can also watch TV directly on the Menu screen.

Using the Tools Menu

Press the **TOOLS** button while you are viewing a channel.

3D Perspective	Select to adjust the 3D perspective NOTE I ▶ This menu can be displayed when convert 2D contents into 3D.
3D Depth	Select to adjust the 3D depth of 2D to 3D conversions. NOTE I ▶ This menu can be displayed when convert 2D contents into 3D.

Picture Mode	Select this to set the picture mode. - Dynamic : Choose this setting to increase Sharpness. - Standard : Choose this setting for most viewing applications. - Movie : This is the best setting for watching movies. - User : Lets you adjust the sharpness and noise reduction function respectively. NOTE I ▶ This menu can not be displayed when you use the BD wise function.
Audio Language	Select to set the desired audio language.
Dual I II	Select to set the desired audio.
Edit Favourites	Select to Edit Favourites.
Signal Information	Select to check the signal information.
PIP	Select to display PIP screen. - PIP : If you select On , you can use PIP function. - Channel : Select to change channels - Size : Select to set PIP screen size. - Position : Select to set PIP screen position. - Sound Select : Select one of Main or Sub which you want to hear the sound.
Audio Description	Select to add a verbal description to the main audio to help the visually impaired.
Subtitle	Select to set the desired subtitle.

DTV Functions

Using the PIP (Picture-In-Picture) function

You can see another TV channel together with the TV Channel you were already watching.

1. While you are watching a TV channel, press the **PIP** button on the remote control. The PIP screen will be displayed.
2. If you do not want to use PIP, press the **PIP** button again while PIP is enabled.
3. You can make various settings for PIP using the Tools menu. (See page 49)

NOTE

- ▶ During Recording, PIP is not supported.
- ▶ PIP and 3D effect can not be enabled in same time.
- ▶ PIP and SMART VIEW can not be enabled in same time.

Editing Channels

Channel List

1. Press the **CH LIST** button on the remote control to see all channels searched. The Channel List will be displayed.

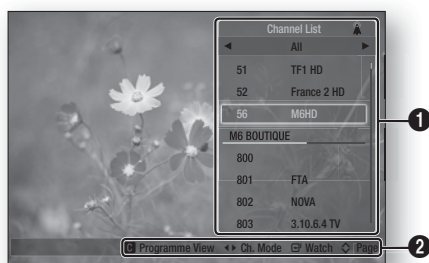

1	Shows the stored channels.
2	Navigation Help : Displays remote control buttons available. <ul style="list-style-type: none"> • YELLOW (C) : Displays the Programme information. • ◀▶ : Shows the channel mode according to channel type. • ☑ : Displays the selected channel. • ▲▼ : Moves to next or previous page.

2. Select desired channel, then press the **☑** button. The selected channel will be displayed.

NOTE

- ▶ When the channel list displayed, press the **INFO** button. You can watch or record the selected channel.

Channel Screen

You can manage the stored channels.

1. In the Home screen, select **Channel**, and then press the **☑** button.

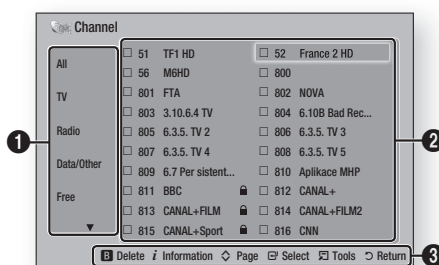

1	Shows the channel list according to channel type.
2	Shows the stored channels.
3	Navigation Help : Displays remote control buttons available. <ul style="list-style-type: none"> • GREEN (B) : Deletes selected channel. • INFO button : Displays the Programme information. • ◀▶ : Moves to next or previous page. • ☑ : Selects desired channel. • TOOLS button : Displays the Tools menu. • RETURN button : Returns to previous menu.

Channel Status Display Icons

Icons	Operations
☆	A channel set as Favourites.
🔒	A locked channel.

Using the Tools Menu

When the channel displayed, press the **TOOLS** buttons.

Edit Favourites	Select this to add the desired favourite channel.
Lock / Unlock	Select this to lock or unlock channels.
Edit Channel Number	Select to edit a channel number. If this menu does not appear, Select Channel on the Home screen, and then select Edit Channel Number . Set this menu to Enable .
Sorting	Select this to sort channels.
Channel Info	Select this to check the channel information of selected or checked channel.
Delete	Select this to delete the channel.
Select All	Select this to select all channels.
Deselect All	Select this to deselect all channels.

Viewing the Guide Screen

The EPG (Electronic Programme Guide) information is provided by broadcasters. Using channel schedules provided by broadcasters, you can specify channels you want to watch in advance so that the channel automatically changes to the selected channel at the specified time. Channel entries may appear blank or out of date depending on a channel status. If you set the Country to New Zealand , Guide screen and Functional Specification on this manual may differ.

1. Press the **GUIDE** button.
The guide screen will be displayed.

• Guide Screen

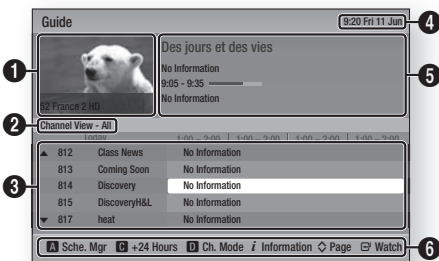

- 1 Displays the channel screen.
- 2 Displays view mode.
- 3 Displays the Stored channels.
- 4 Displays the current date and time.
- 5 Displays the channel information.

Navigation Help : Displays remote control buttons available.



 - **RED (A)** : To set the programme schedule.
 - **YELLOW (C)** : It displays channel from now to 24 hours after.
If you select **YELLOW (C)** button, **GREEN (B)** button will be displayed. Press this to display the list of channels before 24 hours.
 - **BLUE (D)** : To change the Channel View.
 - **INFO** button : Displays the Programme information.
 - **◀▶** : Go to previous page or next page.
 - **⏸** button
 - When you select a programme currently being broadcast, you can watch the selected channel in the full screen.
 - When you select a programme scheduled to broadcast, you can set the Schedule Viewing or Schedule Recording. Press the **◀▶** button to select the Schedule Viewing or Schedule Recording, then press the **⏸** button again. The Timer icon appears on the guide screen.

DTV Functions

Schedule Manager

You can reserve the desired TV programmes using this menu.

Make sure that clock must be set before operating this function. (See page 27)

1. Select **Schedule Manager** on the Home screen, and then press the  button.
2. Press the **RED (A)** button.
3. Select **Schedule Viewing** or **Schedule Recording**, and then press the  button.
4. Fill the input items, and then press the  button.

NOTE









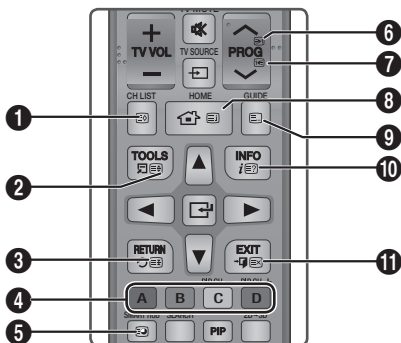

- ▶ In the guide view, Schedule Viewing and Schedule Recording schedules are not displayed.

Using the Teletext Service

If DTV programme supports teletext signal, you can use teletext service. For Teletext information is displayed correctly, channel reception must be stable. Otherwise, information may be missing or some pages may not be displayed.

1. Press **TTX/MIX** button while you are viewing a TV channel.
2. By pressing the **TTX/MIX** button repeatedly, you can change or exit the teletext mode.



1	 : Stores the Teletext pages.
2	 : Displays the teletext on the upper half of the screen in double-size. To move the text to the lower half of the screen, press it again. For normal display, press it once again.
3	 : Holds the display at the current page, in the case that there are several secondary pages that follow automatically. To undo, press it again.
4	Colour buttons (red, green, yellow, blue) : If the FASTEXT system is used by the broadcasting company, the different topics on a Teletext page are colour-coded and can be selected by pressing the coloured buttons. Press the colour corresponding to the topic of your choice. A new colour-coded page is displayed. Items can be selected in the same way. To display the previous or next page, press the corresponding coloured button.
5	 : Displays the available sub-page.
6	 : Displays the next Teletext page.
7	 : Displays the previous Teletext page.
8	 : Displays the index (contents) page at any time while you are viewing Teletext.
9	 : Selects the Teletext mode (LIST/ FLOF). If pressed during LIST mode, switches the mode to List savemode. In List save mode, you can save a Teletext page into a list using the 8(store) button.
10	 : Displays the hidden text (answers to quiz games, for example). To display the normal screen, press it again.
11	 : Shrinks the Teletext display to overlap with the current broadcast.

Typical Teletext page

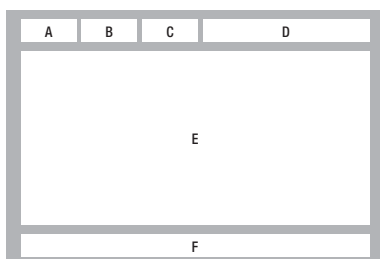

Part	Contents
A	Selected page number.
B	Broadcasting channel identity.
C	Current page number or search indications.
D	Date and time.
E	Text.
F	Status information. FASTEXT information.

| NOTE |

- ▶ Teletext TTX/MIX control is available only when the DTV programme support teletext signal.

Advanced Function

Recording

Before recording

- Please check the default recording device and available storage size in storage device for recording. (please refer to "Storage Device Manager" on page 28.)
- At least 100MB of free space is required for recording.
- Recording will stop if the storage's free space becomes less than 50MB.

Checking Available Storage Size

To check the available storage size in Recorded TV, Select AllShare Play>Recorded TV> HDD in the Home screen.

Highlight the **HDD**, and then press the **INFO** button on the remote control.

| NOTE |

- ▶ Notes on HDD capacity
 - This product reserves HDD capacity internally as described below, for function implementations and this reserved portion is not used for recording.
 - * Time Shift : 22GB
 - * Functional Purpose : 5GB
 - The displayed capacity on OSD which shows approximated available capacity for recording is shown below, calculated based on shipped status.

Model Name	HDD Vendor Specification	Available Size
BD-E8900A	1TB	904GB
BD-E8500A	500GB	438GB



▶ Display of HDD Capacity

- The Capacity of the HDD manufacturer is calculated assuming that 1KB = 1,000 Bytes. However, the operating system of the product calculates the capacity of HDD capacity assuming that 1KB=1,024 Bytes, and therefore detected capacity by this product is about 93% of HDD Manufacturer representation. E.g. for a 1TB(1000GB) HDD, this product detect as 931.3 GB.

| CAUTION |

- ▶ It is recommended to use recorded or edited files with the product for private purposes only.

Recording the current TV channel you are watching

1. Press the **PROG** or number buttons to select a TV Channel you want to record.
2. Press the **REC** button.
3. If you want to adjust length of the recording, press the  button.
4. Select the desired length of the recording, then press the  button.

To pause recording

1. Press the **REC PAUSE** button to pause a recording in progress.
2. Press the **REC** button to resume recording.

To stop recording

Press the  button to stop a recording in progress.

Playback control during recording

During recording a TV channel, you can search scene or move to the beginning point of recording without influence on the recording through Timeshift function.

For more information about Timeshift function, please refer to the Timeshift function.(See pages 55~57)

- buttons : Search the desired scene. Each time this button is pressed, playback speed will change.

▶▶ 1 → ▶▶ 2 → ▶▶ 3 →
 ▶▶ 4 → ▶▶ 5 → ▶▶ 6 → ▶▶ 7

◀◀ 1 → ◀◀ 2 → ◀◀ 3 →
 ◀◀ 4 → ◀◀ 5 → ◀◀ 6 → ◀◀ 7
- button : Return to the beginning point of recording.
- button : Jump to the same scene with Live TV.
- button : Jump to - 10 sec from current position.
- button : Jump to + 10 sec from current position.
- button : Pause the scene while keeping recording progress.
- button : If you are watching the past scene, the playback point will jump to the same scene with Live TV. If you are watching same scene with Live TV, recording will be stopped.

Watching other channels during Recording a TV channel

While a TV programme is being recorded, you can also watch TV channels.

During the recording, press the **PROG** or number buttons to change the channel you want to watch.

I NOTE I

- ▶ During Recording, DUAL VIEW is not supported
- ▶ Recorded files of less than 10 seconds are not saved.

Simultaneous Recording

Simultaneous Recording of Two TV Channels

- While a TV channel is being recorded, move to other TV channel that you want to record.
- Press the **REC** Button.
The recording will be started.

Watching different TV channels that is not under recording

You can watch yet another channel while recording two TV channels at the same time.

- Press the **CH LIST** button to check which TV channel is possible to watch.
White coloured TV Channel in Channel List is what you can move without stopping the recordings already started.
- Press the button to watch the possible TV Channel.
To watch a channel that is not displayed in white, you need to stop at least one of currently recording.

To stop recording

- If you are watching a TV channel which is under recording**

Press the button.

- If you are watching a TV channel which is not under recording**

Select a TV channel what you want to stop the recording, and the press the button.

Simultaneous Operation

You can play a disc or enjoy other function during recording.

- Press the **HOME** button, and then select the Smart Hub or AllShare function. But, you can not select the settings menu unless stop the recording.

Timeshift function

You can pause a live TV or start watching the TV programme from the beginning point you started Timeshift function.

Advanced Function

Start Timeshift with PLAY button

1. When you are watching a TV channel, press the **▶** button.
2. The Timeshift function starts and the Timeshift bar will appear. Live TV is displayed on the left side of Timeshift bar.

Start Timeshift with PAUSE button

1. When you are watching a TV channel, press the **⏸** button.
2. The image of TV programme will be paused, and then Timeshift bar will appear. **⏸** Pause is displayed on the left side of Timeshift bar.

Timeshift information

You can see current information about Timeshift function.

1. Press the **⏮** button on your remote while Timeshift function is enabled.
2. Timeshift bar appears as below.

NOTE

- ▶ The Timeshift settings are sustained even when you switch to another channel in Timeshift operation. In this case, Timeshift of former channel is supported as history function. (The Timeshift of former channel is still available)
- ▶ If Timeshift is started with Play or Pause key, the Timeshift is sustained until the Stop button is pressed. In case when the Timeshift operation becomes not available (such as switching to another application, an analogue channel or changing the input source), Timeshift stops without a notification and will resume automatically as soon as the source is switched to Digital TV.
 - The history function supports only for records of switching within channels of Digital TV source.
 - If switched to an analog channel, history and Timeshift will stop functioning automatically.

- Timeshift automatically stops when selected another menu in the Home menu. (Stops Timeshift and history functions that were operating.)
 - Returning to a Digital TV channel will automatically resumes Timeshift, if not accessed any other menu item of the Home menu.
- ▶ For Timeshift function, 22GB of the internal HDD is reserved.

Timeshift Screen

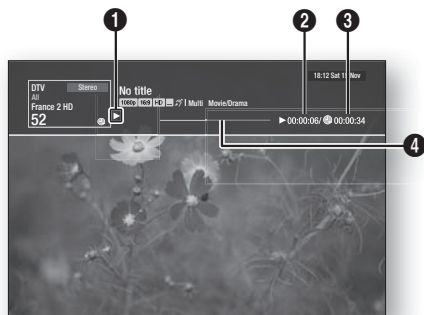

1	Mode Display : Shows current status of Timeshift function.
2	Shows current playback point.
3	Shows recorded time by Timeshift function.
4	Shows progress bar.

Playback control button during Timeshift function is enabled

1. **⏮** **⏭** buttons : Search the desired scene. Each time this button is pressed, playback speed will change.
 - ▶▶ 1 → ▶▶ 2 → ▶▶ 3 →
 - ▶▶ 4 → ▶▶ 5 → ▶▶ 6 → ▶▶ 7
 - ◀◀ 1 → ◀◀ 2 → ◀◀ 3 →
 - ◀◀ 4 → ◀◀ 5 → ◀◀ 6 → ◀◀ 7
2. **⏮** button : return to the beginning of Timeshift.
3. **▶** button : Shows same scene with Live TV.

4. ◀ button : Jump to - 10 sec from current position.
5. ▶ button : Jump to + 10 sec from current position.
6. ⏸ button : Pause the scene while keeping Timeshift operation.
7. ⏪ button : If you are watching the past scene, playback point will jump to the same scene with Live TV. If you are watching the same scene with Live TV, the Timeshift function will be stopped.

To stop Timeshift

1. If Timeshift bar is not in pause or past mode, press ⏪ button. The message "Do you want to stop the Timeshift?" will appear.
2. Select **OK** button and press ⏪ button to stop Timeshift.
3. If the Timeshift bar is in pause or past mode, Timeshift mode will be changed into Live TV when you press ⏪ button first time.
4. Press ⏪ button again, then same message with above image appears.
5. Select **Yes** then press the ⏪ button.

Playing the Recorded Title

1. Select **AllShare Play** on the Home screen, then press the ⏪ button.
2. Select the Recorded TV, then press the ⏪ button. The Recorded TV List will be displayed.
3. Select the desired device, then press the ⏪ button.
4. Select the title you want to play, then press the ⏪ button. The selected title will be played back.

Editing the Recorded Title

1. In the **Recorded TV** screen, select the desired title you want to edit.
2. Press the **TOOLS** button.
3. Select the **Edit**, then press the ⏪ button.

Splitting a Section of a Title (Divide into two)

Follow Steps 1 through 3 in the 'Edit the Recorded Title'.



1. Select the **Split**, then press the ⏪ button.
2. Using the playback-related buttons, move to a point for splitting and then press the ⏪ button.
3. Press the ⏪ button to select Split.
4. Select **OK**, then press the ⏪ button. The split title is divided into two, and the following titles will be shifted down by one.





Advanced Function

Splitting a Section of a Title (Partial Delete)

Follow Steps 1 through 3 in the 'Edit the Recorded Title'.

1. Select the **Partial Delete**, then press the  button.



2. Press the  button at the starting point. The image and starting point time is displayed in the section deletion starting point window.
 - Select the start and end points of the section you want to delete using the playback related buttons.
3. Press the  button at the end point. The image and end point time is displayed in the Section deletion ending point window.
4. Press the  button to select Delete.
5. Select **OK**, then press the  button.

NOTE





- ▶ The minimum length of delete section should be longer than 10 seconds.

Copy

Copying Videos, Music or Photos

Contents	HDD/DISC/ AllShare → USB	DISC/USB/ AllShare → HDD	HDD/DISC/ USB → AllShare
Music	Supported	Supported	Supported
Photos	Supported	Supported	Supported
Videos	Supported	Supported	Supported

- Disc (CD-DA/CD-R/CD-RW, DVD±R(Finalise)/DVD+RW/DVD-RW(Finalise)) → HDD or USB
- PTP USB is not available when you copy to USB.
- The broadcast signal can be recorded on HDD but copy feature is not supported.

1. Press the **HOME** button. The home screen will be displayed.
2. In Stop mode, connect the USB storage device to the USB port on the front panel of the product.
3. Select the desired contents type, then press the  button.
4. Select the desired contents.
5. Press the **TOOLS** button.
6. Select the **Send**, then press the  button.
7. Press the  button to check desired files.
8. Select the **Send**, then press the  button. To cancel the copying in progress, press the  button.

3D Functions

3D Converter

This function can convert the 2D output of 2D contents into 3D.

1. Connect this product to a TV that supports 3D using an HDMI cable.
2. When you play 2D contents, press the **2D→3D** button on the remote control to convert 2D into 3D contents.
3. You can toggle between 2D and 3D by pressing the **2D→3D** button repeatedly. If you are playing 3D contents in the 3D mode, you cannot use this function.

| NOTE |

- ▶ You can't convert 2D contents into 3D or use the **2D→3D** button in the following cases:
 - When the product is not connected with an HDMI cable
 - When the connected TV does not support 3D
 - When you are playing 3D contents (disc, file).
- ▶ 2D content is converted into the following 3D formats:
 - 1080p 24fps : Output to 1080p 24 fps 3D.
 - Others : Output to 720p 3D.
 - Photo files : Output to 720p 3D.
- ▶ 2D content that the product can convert to 3D:
 - 2D content that supports 3D conversion
 - Smart Hub content, DVD Video, BD-ROM, Video files, photo files, DTV programme, and recorded DTV programme.
- ▶ When you use the 3D converter, the BONUSVIEW function is not available.
(Depending on the disc, a black outline appears.)
- ▶ Some viewers may experience discomfort while viewing 3D contents such as dizziness, nausea, and headaches.

Adjusting the 3D Depth

The 3D Depth function lets you adjust the 3D depth of 2D to 3D conversions. Values range from 1 to 10. The higher the number, the deeper the 3D depth.

1. When you are viewing converted 3D contents, press the **TOOLS** button.
2. Press the **▲▼** buttons to select **3D Depth**, and then press the **⏏** button.
3. Adjust the 3D Depth using the **◀▶** buttons.

Viewing DTV with the 3D effect

You can experience 3D effect with all live TV programme and recorded TV programme.

1. During watching the TV programme or playing recorded TV programme, press the **2D→3D** button on your remote control. The 3D menu will appear.
 - **2D→3D** : Changes a 2D image to 3D.
 - **Side by Side** : Displays two images next to each other.
 - **Top and Bottom** : Displays one image above another.
2. Press the **◀▶** buttons to select the desired 3D mode, then press the **⏏** button.
3. If you press the **2D→3D** button once more during 3D viewing, displayed image will be changed into 2D mode.

| NOTE |

- ▶ If you change TV channel during watching DTV in 3D mode of Side by Side mode, displayed image will be changed into 2D mode automatically.
- ▶ When 3D effect of Side by Side mode is enabled, you can not adjust 3D mode.
- ▶ If TV programme is not support Side by Side, Top and Bottom mode or Auto Detection function, 3D menu selection OSD is not appear.
- ▶ 3D Effect and SMART VIEW can not be enabled in same time.

Network Services

You can enjoy various network services such as Smart Hub or BD-LIVE by connecting the product to your network.

To use network services, you must first:

1. Connect the product to the network. (See page 20)
2. Configure the network settings. (See pages 31~33)

Using Smart Hub

Using Smart Hub, you can download movies, videos, and music from the Internet, and access various for pay or free-of-charge applications and view them on your TV. Application content includes news, sports, weather forecasts, stock market quotes, maps, photos, and games.

For instructions that explain how to use Smart Hub, follow these steps:

If the home page is updated or revised, the content mentioned in the user manual may differ from the actual menus.

1. Go to www.samsung.com.
2. Click Support at the top of the page.
3. On the Support page, enter the model number of your product into the Model Number field, and then press **Enter** button.
4. On the page that appears, click Get downloads on the left side under Downloads. The Download Centre appears.
5. On the Download Centre page, click the Manuals tab.
6. On the Manuals tab, click the file icon to the right of Smart Hub Users Manual. The manual downloads.

NOTE

- ▶ The web location of the Smart Hub manual is subject to change without notice.

Smart Hub at a Glance

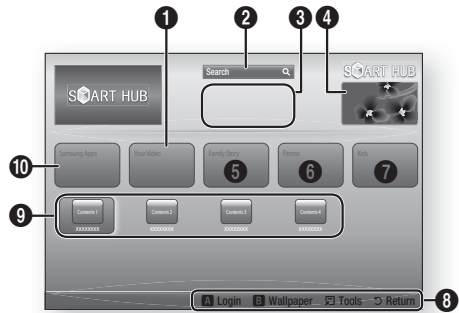

1	Your Video : Provides recommendations for videos based on your tastes.
2	Search : Provides an integrated search of your video providers and connected AllShare devices.
3	Recommended : Displays recommended contents managed by Samsung.
4	Commercial : Displays the Smart Hub Guide, an introduction to the product, and new application introductions.
5	Family Story : Effortless way to access family content. <ul style="list-style-type: none"> • Provides access to family photos, messages, and events, anytime and anywhere.
6	Fitness : Gateway to the Unified Self-Care Service. <ul style="list-style-type: none"> • Presents fitness videos from various content partners with feedback on calories burned after every workout.
7	Kids : Kids service gives kids an easy and safe way to enjoy their favorite content. <ul style="list-style-type: none"> • Provides a wide variety of fun and safe content for children.
8	Navigation Help : Displays the remote control buttons you can use to navigate in Smart Hub. <ul style="list-style-type: none"> • RED (A) : To log in to Smart Hub. • GREEN (B) : To display the background screen. • Tools : To display the settings window. • Return : To return to the previous menu.

9	My Applications : Displays your personal gallery of applications which you can add to, modify, and delete.
10	Samsung Apps : Open Samsung Apps to download various for pay or free-of-charge application services.

Using the Web Browser

You can access the internet using the Web Browser application which is installed in the Smart Hub screen by default.

1. Select **Smart Hub** on the Home screen, and then press the  button.
2. Select the Web Browser application in Smart Hub, and then press the  button.













NOTE

- ▶ To change PIP channels, press the **PROG** button on the remote control.
The **PIP CH+** and **PIP CH-** buttons on the remote control does not operate.
- ▶ When you run the Web Browser with the product connected by HDMI to a BD Wise compatible TV - and BD Wise is on - the browser is maximized to fill the screen and the TV's resolution is set to the optimal resolution automatically.
- ▶ The Web Browser is not compatible with Java applications.
- ▶ If you attempt to download a file, and the file can not be saved, an error message will appear.
- ▶ The playback of Flash videos is not supported.
- ▶ E-commerce, for purchasing products online, is not supported.
- ▶ ActiveX is not supported.

Web Browser at a Glance



Control Panel : Displays the various Web Browser functions.

-  : Moves to the previous page.
-  : Moves to the last page before going back.
-  : Reloads the current page so that it is refreshed on the screen.
-  : Moves to the Home screen of the Web Browser.
-  : Allows you to zoom in or out of the screen at various percentages.
-  : Allows you to bookmark specific pages so that you can move to them easily.
-  : Allows you to view the history of your visited pages by date, name, or frequency.
-  : Allows you to enter a page address manually or select a page from the visited page list to move to that page.
-  : Allows you to switch easily between multiple, currently open Web Browser windows.
-  : Allows you to search for information by entering words.
-  : Lets you share the current site with your family group by sending a message.
-  : Allows you to configure all settings for using the Web Browser.

Network Services







Navigation Help : Displays the remote control buttons you can use to navigate in Web Browser.

2

- **GREEN (B)** : To display the Control Panel.
- **YELLOW (C)** : To switch the pointer.
- **BLUE (D)** : To use the PIP function.
- **Tools** : To display Tools window.
- **Exit** : To exit the Web Browser.

BD-LIVE™

Once the product is connected to your network, you can enjoy various movie-related service contents available on BD-LIVE compliant discs.

1. Attach a USB memory stick to the USB jack on the front of the product, and then check its remaining memory. The memory device must have at least 1GB of free space to accommodate the BD-LIVE services.
2. Select **Settings** on the Home screen, and then press the  button.
3. Select **Network**, and then press the  button.
4. Select **BD Live Settings**, and then press the  button.
5. Select **Delete BD Data**, and then press the  button.
6. Select **Select Device**, and then press the  button.
7. Select **USB**, and then press the  button.
8. Insert a Blu-ray Disc that supports BD-LIVE.
9. Select an item from the list of BD-LIVE service contents provided by the disc manufacturer.

| NOTE |

- ▶ The way you use BD-LIVE and the provided contents may differ, depending on the disc manufacturer.

Samsung Smart View

This function is available via Samsung Smart View app for Samsung BD-HDD Combo.

To Enjoy Smart View, your BD-HDD Combo and mobile device should be connected via Wi-Fi. The connection can be established as follows

1. BD-HDD Combo and mobile device are Connected to the same wireless Router
2. Mobile device is connected to BD-HDD Combo directly via Soft AP function in Network Menu.
3. If your mobile device supports Wi-Fi Direct, it can connect to BD-HDD Combo directly via Wi-Fi Direct function in Network Menu.

Dual View

Enjoy TV channel right from your mobile device that's connected to Samsung BD-HDD Combo. You can view the same channel of TV, or a different channel than selected on TV, on your mobile device at the same time.

| NOTE |

- ▶ Available only if the mobile device supports this function.
- ▶ Samsung Smart View is a dedicated application to Samsung smart phone/tablet. If you have a Samsung smart phone/tablet supporting this feature (Smart View), you can download Smart View from Android Market or Samsung Apps and install it on your device. (The compatibility of mobile devices or mobile platform is subject to change in the future.)

Compliance and Compatibility Notice

NOT ALL discs are compatible

- Subject to the restrictions described below and those noted throughout this Manual, including the Disc Type and Characteristics section of this user manual, disc types that can be played are: pre-recorded commercial BD-ROM, DVD-VIDEO, and Audio CD (CD-DA); BD-RE/R, DVD-RW/-R; and CD-RW/R.
- Discs other than the above cannot and/or is not intended to be played by this product. And some of the above discs may not play due to one or more reasons provided below.
- Samsung cannot assure that this product will play every disc bearing the BD-ROM, BD-RE/R, DVD-VIDEO, DVD-RW/-R, DVD+RW/+R and CD-RW/R logos, and this product may not respond to all operating commands or operate all features of every disc. These and other disc compatibility and product operation issues with new and existing format discs are possible because:
 - Blu-ray is a new and evolving format and this product may not operate all features of Blu-ray Discs because some features may be optional, additional features may have been added to the Blu-ray Disc format after the production of this product, and certain available features may be subject to delayed availability;
 - not all new and existing disc format versions are supported by this product;
 - new and existing disc formats may be revised, changed, updated, improved and/or supplemented;
 - some discs are produced in a manner that allows specific or limited operation and feature during playback;
 - some features may be optional, additional features may have been added after the production of this product or certain available features may be subject to delayed availability;
 - some discs bearing the BD-ROM, BD-RE/R, DVD-VIDEO, DVD-RW/-R, DVD+RW/+R and CD-RW/R logos may still be non-standardized discs;
 - some discs may not be played depending on their physical state or recording conditions;
 - problems and errors can occur during the creation of Blu-ray Disc, DVD software and/or the manufacture of discs;
 - this product operates differently than a standard DVD product or other AV equipment; and/or
 - for reasons noted throughout this user manual and for other reason(s) discovered and posted by SAMSUNG customer care centre.
- If you encounter disc compatibility or product operation problems, please contact SAMSUNG customer care centre.
You may also contact SAMSUNG customer care centre for possible updates on this product.
- For additional information on playback restrictions and disc compatibility, refer to the Precautions, Before Reading the user manual, Disc Types and Characteristics, and Before Playing sections of this user manual.

Copy Protection

- Because AACS (Advanced Access Content System) is approved as content protection system for Blu-ray Disc format, similar to use of CSS (Content Scramble System) for DVD format, certain restrictions are imposed on playback, analogue signal output, etc., of AACS protected contents. The operation of this product and restrictions on this product may vary depending on your time of purchase as those restrictions may be adopted and/or changed by AACS after the production of this product. Furthermore, BD-ROM Mark and BD+ are additionally used as content protection system for Blu-ray Disc format, which imposes certain restrictions including playback restrictions for BD-ROM Mark and/or BD+ protected contents. To obtain additional information on AACS, BD-ROM Mark, BD+, or this product, please contact SAMSUNG customer care centre.

- Many Blu-ray Disc/DVDs are encoded with copy protection. Because of this, you should only connect your Product directly to your TV, not to a VCR. Connecting to a VCR results in a distorted picture from copy-protected Blu-ray Disc/DVDs.

- This item incorporates copy protection technology that is protected by U.S. patents and other intellectual property rights of Rovi Corporation. Reverse engineering and disassembly are prohibited.

- Under the U.S. Copyright laws and Copyright laws of other countries, unauthorized recording, use, display, distribution, or revision of television programmes, videotapes, Blu-ray Discs, DVDs, and other materials may subject you to civil and/or criminal liability.

- **Cinavia Notice** : This product uses Cinavia technology to limit the use of unauthorized copies of some commercially-produced film and videos and their soundtracks. When a prohibited use of an unauthorized copy is detected, a message will be displayed and playback or copying will be interrupted.

More information about Cinavia technology is provided at the Cinavia Online Consumer Information Centre at <http://www.cinavia.com>. To request additional information about Cinavia by mail, send a postcard with your mailing address to: Cinavia Consumer Information Centre, P.O. Box 86851, San Diego, CA, 92138, USA.

This product incorporates proprietary technology under licence from Verance Corporation and is protected by U.S. Patent 7,369,677 and other U.S. and worldwide patents issued and pending as well as copyright and trade secret protection for certain aspects of such technology. Cinavia is a trademark of Verance Corporation. Copyright 2004-2010 Verance Corporation. All rights reserved by Verance. Reverse engineering or disassembly is prohibited.

Network Service Disclaimer

All content and services accessible through this device belong to third parties and are protected by copyright, patent, trademark and/or other intellectual property laws. Such content and services are provided solely for your personal noncommercial use. You may not use any content or services in a manner that has not been authorized by the content owner or service provider. Without limiting the foregoing, unless expressly authorized by the applicable content owner or service provider, you may not modify, copy, republish, upload, post, transmit, translate, sell, create derivative works, exploit, or distribute in any manner or medium any content or services displayed through this device.

THIRD PARTY CONTENT AND SERVICES ARE PROVIDED "AS IS." SAMSUNG DOES NOT WARRANT CONTENT OR SERVICES SO PROVIDED, EITHER EXPRESSLY OR IMPLIEDLY, FOR ANY PURPOSE. SAMSUNG EXPRESSLY DISCLAIMS ANY IMPLIED WARRANTIES, INCLUDING BUT NOT LIMITED TO, WARRANTIES OF MERCHANTABILITY OR FITNESS FOR A PARTICULAR PURPOSE. SAMSUNG DOES NOT GUARANTEE THE ACCURACY, VALIDITY, TIMELINESS, LEGALITY, OR COMPLETENESS OF ANY CONTENT OR SERVICE MADE AVAILABLE THROUGH THIS DEVICE AND UNDER NO CIRCUMSTANCES, INCLUDING NEGLIGENCE, SHALL SAMSUNG BE LIABLE, WHETHER IN CONTRACT OR TORT, FOR ANY DIRECT, INDIRECT, INCIDENTAL, SPECIAL OR CONSEQUENTIAL DAMAGES, ATTORNEY FEES, EXPENSES, OR ANY OTHER DAMAGES ARISING OUT OF, OR IN CONNECTION WITH, ANY INFORMATION CONTAINED IN, OR AS A RESULT OF THE USE OF ANY CONTENT OR SERVICE BY YOU OR ANY THIRD PARTY, EVEN IF ADVISED OF THE POSSIBILITY OF SUCH DAMAGES.

Third party services may be terminated or interrupted at any time, and Samsung makes no representation or warranty that any content or service will remain available for any period of time. Content and services are transmitted by third parties by means of networks and transmission facilities over which Samsung has no control. Without limiting the generality of this disclaimer, Samsung expressly disclaims any responsibility or liability for any interruption or suspension of any content or service made available through this device.

Samsung is neither responsible nor liable for customer service related to the content and services. Any question or request for service relating to the content or services should be made directly to the respective content and service providers.

Samsung is neither responsible nor liable for customer service related to the content and services. Any question or request for service relating to the content or services should be made directly to the respective content and service providers.

Licence

- Dolby and the double-D symbol are registered trademarks of Dolby Laboratories.
- Manufactured under licence under U.S. Patent Nos: 5,956,674; 5,974,380; 6,226,616; 6,487,535; 7,212,872; 7,333,929; 7,392,195; 7,272,567 & other U.S. and worldwide patents issued & pending. DTS-HD, the Symbol, & DTS-HD and the Symbol together are registered trademarks & DTS-HD Master Audio is a trademark of DTS, Inc. Product includes software. © DTS, Inc. All Rights Reserved.
- DivX
 - ABOUT DIVX VIDEO: DivX® is a digital video format created by DivX, LLC, a subsidiary of Rovi Corporation. This is an official DivX Certified® device that plays DivX video. Visit divx.com for more information and software tools to convert your files into DivX videos.
 - ABOUT DIVX VIDEO-ON-DEMAND: This DivX Certified® device must be registered in order to play purchased DivX Video-on-Demand (VOD) movies. To obtain your registration code, locate the DivX VOD section in your device setup menu. Go to vod.divx.com for more information on how to complete your registration.



Appendix

- DivX Certified® to play DivX® video up to HD 1080p, including premium content. DivX®, DivX Certified® and associated logos are trademarks of Rovi Corporation or its subsidiaries and are used under license.

Covered by one or more of the following U.S. patents : 7,295,673; 7,460,668; 7,515,710; 7,519,274

- The terms HDMI and HDMI High-Definition Multimedia Interface, and the HDMI Logo are trademarks or registered trademarks of HDMI Licensing LLC in the United States and other countries.



- Oracle and Java are registered trademarks of Oracle and/or its affiliates. Other names may be trademarks of their respective owners



- Rovi Flow-Down Licence Terms (Terms of Use)

- This application incorporates software and technology of Rovi Corporation ("Rovi"). The Rovi software and technology (collectively, the "Rovi Technology") allows End Users to access music-related data ("Rovi Data") over the Internet and otherwise from proprietary Rovi databases (the "Rovi Databases") located on Rovi servers (the "Rovi Servers") and to perform other functions. You may access and use Rovi Data only by means of the intended End User functions of this application software.
- You agree that you will use the Rovi Data, the Rovi Technology, and the Rovi Servers for your own personal non-commercial use only. You agree not to assign, copy, transfer or transmit the Rovi Data to any third party. You agree not to use or exploit Rovi Data, the Rovi Technology, the Rovi Databases, or the Rovi Servers, except as expressly permitted herein.
- You agree that your non-exclusive licence to access the Rovi Databases and to use the Rovi Data, the Rovi Technology, and the Rovi Servers will terminate if you violate these restrictions. If your licence terminates, you agree to cease any and all use of the Rovi Data, the Rovi Technology, and the Rovi Servers. Rovi reserves all rights in Rovi Data, the Rovi Technology, and Rovi Servers, including all ownership rights. You agree that Rovi may enforce its rights under this Agreement against you directly in its own name.
- Rovi reserves the right to delete data from the Rovi Databases or to change data categories for any cause that Rovi deems sufficient. No warranty is made that the Rovi Technology or Rovi Servers are error-free or that functioning of Rovi Technology or Rovi Servers will be uninterrupted. Rovi is not obligated to provide you with any new enhanced or additional data types or categories that Rovi may choose to provide in the future and is free to discontinue its online services at any time.
- The data you submit to use will not be personal data or personally identifiable data, but rather only data respecting music albums and associated data that does not appear in the Rovi Lookup Database. You certify that to the best of its knowledge the album to which the submitted data corresponds is commercially available and that you End User are lawfully permitted to submit the data.

- To the extent that you, the End User, provide any information or original works of authorship to be added to Rovi Databases, you represent and warrant that you are the sole author of such work(s) and further hereby assign to Rovi all rights of copyright therein, including the right to register the copyright in such work(s) as part of the Rovi Database.
- THE ROVITECHNOLOGY AND EACH ITEM OF ROVI DATA ARE LICENCED TO YOU "AS IS." ROVI MAKES NO REPRESENTATIONS OR WARRANTIES, EXPRESS OR IMPLIED, REGARDING THE ACCURACY OF ANY ROVI DATA ON THE ROVI SERVERS. ROVI DISCLAIMS ALL WARRANTIES EXPRESS OR IMPLIED, INCLUDING, BUT NOT LIMITED TO, IMPLIED WARRANTIES OF MERCHANTABILITY, FITNESS FOR A PARTICULAR PURPOSE, TITLE AND NON-INFRINGEMENT. ROVI DOES NOT WARRANT THE RESULTS THAT WILL BE OBTAINED BY YOUR USE OF THE ROVI TECHNOLOGY OR ANY ROVI SERVER. IN NO CASE WILL ROVI BE LIABLE TO YOU OR ANY THIRD PARTY FOR ANY CONSEQUENTIAL OR INCIDENTAL DAMAGES OR FOR ANY LOST PROFITS OR LOST REVENUES RESULTING FROM YOUR USE OF ROVI DATA, THE ROVI TECHNOLOGY OR OTHERWISE.
- Open Source Licence Notice
 - In the case of using open source software, Open Source Licences are available on the product menu.
- Blu-ray Disc™, Blu-ray™, and the logos are trademarks of Blu-ray Disc Association.

Additional Information

Note

Settings	3D Settings
	<ul style="list-style-type: none"> • For some 3D discs, to stop a movie during 3D playback, press the □ button once. The movie stops and the 3D mode option is de-activated. To change a 3D option selection when you are playing a 3D movie, press the □ button once. The Blu-ray menu appears. Press the □ button again, then select 3D Settings in the Blu-ray menu. • Depending on the content and the position of the picture on your TV screen, you may see vertical black bars on the left side, right side, or both sides.
	TV Aspect Ratio
	<ul style="list-style-type: none"> • Depending on the disc type, some aspect ratios may not be available. • If you select an aspect ratio and option which is different than the aspect ratio of your TV screen, then the picture might appear to be distorted. • If you select the 16:9 Original, your TV may display 4:3 Pillarbox (black bars on sides of picture).
	BD Wise (Samsung Products only)
	<ul style="list-style-type: none"> • When BD Wise is on, the Resolution setting automatically defaults to BD Wise and BD Wise appears in the Resolution menu. • If the product is connected to a device that does not support BD Wise, you can not use the BD Wise function. • For proper operation of BD Wise, set the BD Wise menu of both the product and the TV to On.
	Digital Output
	<ul style="list-style-type: none"> • Be sure to select the correct Digital Output or you will hear no sound or just loud noise. • If the HDMI device (AV receiver, TV) is not compatible with compressed formats (Dolby Digital, DTS), the audio signal outputs as PCM. • Regular DVDs do not have BONUSVIEW audio and Navigation Sound Effects.
PCM Downsampling	
<ul style="list-style-type: none"> • Even when PCM Downsampling is set to Off, some discs will only output downsampled audio through the optical digital outputs. • HDMI <ul style="list-style-type: none"> - If your TV is not compatible with compressed multi-channel formats (Dolby Digital, DTS), the product may output PCM 2ch downmixed audio even though you selected Bitstream (either Reencoded or Unprocessed) in the setup menu. - If your TV is not compatible with PCM sampling rates over 48kHz, the product may output 48kHz. 	

Settings	BD-LIVE Internet Connection
	<ul style="list-style-type: none"> • What is a valid certificate? When the product uses BD-LIVE to send the disc data and a request to the server to certify the disc, the server uses the transmitted data to check if the disc is valid and sends the certificate back to the product. • The Internet connection may be restricted while you are using BD-LIVE contents.
	Delete BD Data
	<ul style="list-style-type: none"> • In the external memory mode, disc playback may be stopped if you disconnect the USB device in the middle of playback. • Only those USB devices formatted in FAT file system (DOS 8.3 volume label) are supported. We recommend you use USB devices that support USB 2.0 protocol with 4 MB/sec or faster read/write speed. • The Resume Play function may not work after you format the storage device. • The total memory available to Delete BD Data may differ, depending on the conditions.
Media Play	Anynet+(HDMI-CEC)
	<ul style="list-style-type: none"> • Depending on your TV, certain HDMI output resolutions may not work. Please refer to the user manual of your TV. • This function is not available if the HDMI cable does not support CEC. • If your Samsung TV has an Anynet+ logo, then it supports the Anynet+ function.
Media Play	Selecting the Audio Language
	<ul style="list-style-type: none"> • The ◀▶ indicator will not appear on the screen if the BONUSVIEW section does not contain any BONUSVIEW audio settings. • The languages available through the Audio Language function depend on the languages that are encoded on the disc. This function or certain languages may not be available. • Some Blu-ray Discs may allow you to select either the PCM or Dolby Digital audio soundtrack in English.
Media Play	Selecting the Subtitle Language
	<ul style="list-style-type: none"> • Depending on the Blu-ray Disc / DVD, you may be able to change the desired subtitle in the Disc Menu. Press the DISC MENU button. • This function depends on the selection of subtitles that are encoded on the disc and may not be available on all Blu-ray Discs/DVDs. • Information about the main feature BONUSVIEW mode will also appear if the Blu-ray Disc has a BONUSVIEW section. • This function changes both the primary and secondary subtitles at the same time. • The total numbers of primary and secondary subtitles are displayed respectively. • If you press the SUBTITLE button on the remote control, the subtitle bar appears. Press the RETURN button to remove the subtitle bar.

Appendix

Resolution according to the output mode

■ Blu-ray Disc/E-contents/Digital Contents playback

Setup \ Contents Type	HDMI / connected			HDMI / not connected
	HDMI Mode		VIDEO Mode	VIDEO Mode
	Blu-ray Disc	E-contents/ Digital contents		
BD Wise	Resolution of Blu-ray Disc	1080p	576i/480i	-
Auto	Max. Resolution of TV input	Max. Resolution of TV input	576i/480i	-
1080p	1080p	1080p	576i/480i	-
Movie Frame : Auto (24Fs)	1080@24F	1080@24F	480i	-
1080i	1080i	1080i	576i/480i	576i/480i
720p	720p	720p	576i/480i	576i/480i
576p/480p	576p/480p	576p/480p	576i/480i	576i/480i
576i/480i	-	-	-	576i/480i

■ DVD playback

Setup \ Output	HDMI / connected		HDMI / not connected
	HDMI Mode	VIDEO Mode	VIDEO Mode
BD Wise	576i/480i	576i/480i	-
Auto	Max. Resolution of TV input	576i/480i	-
1080p	1080p	576i/480i	-
1080i	1080i	576i/480i	576i/480i
720p	720p	576i/480i	576i/480i
576p/480p	576p/480p	576i/480i	576i/480i
576i/480i	-	-	576i/480i

■ DTV View

Resolution \ Output		HDMI / connected		HDMI / not connected
		HDMI Mode	VIDEO Mode	VIDEO Mode
BD Wise		1080p	576i/480i	-
Auto	DTV Smart Resolution "Auto"	Resolution of Broadcast stream	576i/480i	-
	DTV Smart Resolution "Off"	Max Resolution of TV input		
1080p		1080p	576i/480i	-
1080i		1080i	576i/480i	576i/480i
720p		720p	576i/480i	576i/480i
576p/480p		576p/480p	576i/480i	576i/480i
576i/480i		-	-	576i/480i

| NOTE |

- ▶ DTV smart resolution is activated only when resolution option is set to Auto.
- ▶ If the TV you connected to the product does not support Movie Frame or the resolution you selected, the message *"If no pictures are shown after selecting Yes, please wait for 15 seconds before returning to the previous resolution. Do you want to change the resolution?"* appears. If you select **Yes**, the TV's screen will go blank for 15 seconds, and then the resolution will revert to the previous resolution automatically.
- ▶ If the screen stays blank after you have changed the resolution, remove all discs, and then press and hold the **■** button on the front of the product for more than 5 seconds. All settings are restored to the factory default. Follow the steps on the previous page to access each mode and select the Display Setup that your TV will support.
- ▶ When the factory default settings are restored, all stored user BD data is deleted.
- ▶ The Blu-ray Disc must have the 24 frame feature for the product to use the Movie Frame (24Fs) mode.

Appendix

Digital Output Selection

Setup		PCM		Bitstream (Unprocessed)		Bitstream (Re-encoded DTS)	Bitstream (Re-encoded Dolby D)
		HDMI supported AV receiver	Optical	HDMI supported AV receiver	Optical	HDMI supported AV receiver or Optical	HDMI supported AV receiver or Optical
Audio Stream on Blu-ray Disc	PCM	Up to PCM 7.1ch	PCM 2ch	PCM	PCM 2ch	Re-encoded DTS	Re-encoded Dolby Digital *
	Dolby Digital	Up to PCM 7.1ch	PCM 2ch	Dolby Digital	Dolby Digital	Re-encoded DTS	Re-encoded Dolby Digital *
	Dolby Digital Plus	Up to PCM 7.1ch	PCM 2ch	Dolby Digital Plus	Dolby Digital	Re-encoded DTS	Re-encoded Dolby Digital *
	Dolby TrueHD	Up to PCM 7.1ch	PCM 2ch	Dolby TrueHD	Dolby Digital	Re-encoded DTS	Re-encoded Dolby Digital *
	DTS	Up to PCM 6.1ch	PCM 2ch	DTS	DTS	Re-encoded DTS	Re-encoded Dolby Digital *
	DTS-HD High Resolution Audio	Up to PCM 7.1ch	PCM 2ch	DTS-HD High Resolution Audio	DTS	Re-encoded DTS	Re-encoded Dolby Digital *
	DTS-HD Master Audio	Up to PCM 7.1ch	PCM 2ch	DTS-HD Master Audio	DTS	Re-encoded DTS	Re-encoded Dolby Digital *
Audio Stream on DVD	PCM	PCM 2ch	PCM 2ch	PCM 2ch	PCM 2ch	PCM 2ch	PCM 2ch
	Dolby Digital	Up to PCM 5.1ch	PCM 2ch	Dolby Digital	Dolby Digital	Dolby Digital	Dolby Digital
	DTS	Up to PCM 6.1ch	PCM 2ch	DTS	DTS	DTS	DTS
Audio Stream of Broadcast	Dolby Digital	Up to PCM 5.1ch	PCM 2ch	Dolby Digital	Dolby Digital	Re-encoded DTS	Re-encoded Dolby Digital
	Dolby Digital Plus	Up to PCM 5.1ch	PCM 2ch	Dolby Digital Plus**	Dolby Digital	Re-encoded DTS	Re-encoded Dolby Digital
	MPEG1 Layer 2	PCM 2ch	PCM 2ch	PCM 2ch	PCM 2ch	PCM 2ch	PCM 2ch
	HE-AAC	Up to PCM 5.1ch	PCM 2ch	Re-encoded Dolby Digital	Re-encoded Dolby Digital	Re-encoded DTS	Re-encoded Dolby Digital

Setup		PCM		Bitstream (Unprocessed)		Bitstream (Re-encoded DTS)	Bitstream (Re-encoded Dolby D)
Connection		HDMI supported AV receiver	Optical	HDMI supported AV receiver	Optical	HDMI supported AV receiver or Optical	HDMI supported AV receiver or Optical
Definition for Blu-ray Disc	Any	Decodes the main feature audio and BONUSVIEW audio stream together into PCM audio and adds Navigation Sound Effects.		Outputs only the main feature audio stream so that your AV receiver can decode the audio bitstream. You will not hear BONUSVIEW audio or Navigation Sound Effects.		Decodes the main feature audio and BONUSVIEW audio stream together into PCM audio and adds Navigation Sound Effects, then re-encodes the PCM audio into DTS bitstream.	Decodes the main feature audio and BONUSVIEW audio stream together into PCM audio and adds Navigation Sound Effects, then re-encodes the PCM audio into Dolby Digital bitstream.

* If the Source Stream is 2ch or mono, "Re-encoded Dolby D" setting is not applied. Output will be PCM 2ch.

** If the Audio Description is set to **On**, audio output will be changed Dolby Digital even if the original broadcast stream is Dolby Digital Plus.

| NOTE |

- ▶ For Dolby Digital Plus stream on Internet Content, PCM Output via HDMI supported up to 5.1ch.

Troubleshooting

Before requesting service, please try the following solutions.

PROBLEM	SOLUTION
No operation can be performed with the remote control.	<ul style="list-style-type: none"> • Check the batteries in the remote control. They may need replacing. • Operate the remote control at a distance of no more than 6.1m. • Remove the batteries and hold down one or more buttons for several minutes to drain the microprocessor inside the remote control to reset it. Reinstall the batteries and try to operate the remote control again.
Disc does not play.	<ul style="list-style-type: none"> • Ensure that the disc is installed with the label side facing up. • Check the region number of the Blu-ray/DVD disc.
Disc Menu does not appear.	<ul style="list-style-type: none"> • Ensure that the disc has disc menus.
The prohibition message appears on the screen.	<ul style="list-style-type: none"> • This message appears when an invalid button is pressed. • The Blu-ray Disc/DVD's software doesn't support the feature (e.g., angles). • You've requested a title or chapter number or search time that is out of range.
Play mode differs from the Setup Menu selection.	<ul style="list-style-type: none"> • Some of the functions selected in the Setup Menu may not work properly if the disc is not encoded with the corresponding function.
The screen ratio cannot be changed.	<ul style="list-style-type: none"> • The Screen Ratio is fixed on your Blu-ray/DVD disc. • This is not a problem with the product.
No audio.	<ul style="list-style-type: none"> • Make sure you have selected the correct Digital Output in the Audio Options Menu.
The screen is blocked	<ul style="list-style-type: none"> • If the HDMI output is set to a resolution your TV cannot support (for example, 1080p), you may not see a picture on your TV. • Press the ■ button (on front panel) for more than 5 seconds with no disc inside. All settings will revert to the factory settings. • When the factory default settings are restored, all stored user BD data is deleted.
Forgot password	<ul style="list-style-type: none"> • Press the ■ button (on front panel) for more than 5 seconds with no disc inside. All settings including the password will revert to the factory settings. Don't use this unless absolutely necessary. • When the factory default settings are restored, all stored user BD data is deleted.

PROBLEM	SOLUTION
If you experience other problems.	<ul style="list-style-type: none"> • Go to the contents and find the section of the user manual that contains the explanations regarding the current problem, and follow the procedure once again. • If the problem still cannot be solved, please contact your nearest Samsung authorized service centre.
The picture is noisy or distorted	<ul style="list-style-type: none"> • Make sure that the disc is not dirty or scratched. • Clean the disc.
No HDMI output.	<ul style="list-style-type: none"> • Check the connection between the TV and the HDMI jack of the product. • Check if your TV supports 480p, 720p, 1080i, 1080p HDMI input resolution.
Abnormal HDMI output screen.	<ul style="list-style-type: none"> • If random noise appears on the screen, it means that TV does not support HDCP (High-bandwidth Digital Content Protection).
AllShare function	
I can see folders shared through AllShare, but I cannot see the files.	<ul style="list-style-type: none"> • AllShare shows only files corresponding to the Videos, Photos, and Music categories. Files that do not correspond to these categories may not be displayed.
Video is played intermittently.	<ul style="list-style-type: none"> • Check if the network is stable. • Check if the network cable is properly connected and if the network is not overloaded. • The wireless connection between the DLNA compatible device and the product is unstable. Check the connection.
AllShare connection between product and PC is unstable.	<ul style="list-style-type: none"> • The IP address under the same subnetwork should be unique. If they are not, IP interference can cause this phenomenon. • Check if you have a firewall enabled. If so, disable the firewall function.

Appendix

PROBLEM	SOLUTION
BD-LIVE	
I cannot connect to the BD-LIVE server.	<ul style="list-style-type: none">• Check whether the network connection is successful or not by using the Network Status menu. (See page 27)• Check whether the USB memory device is connected to the product.• The memory device must have at least 1GB of free space to accommodate the BD-LIVE service. You can check the available size in Delete BD Data. (See page 27)• Check whether the BD-LIVE Internet Connection menu is set to Allow(All).• If all above fails, contact the contents provider or update the product to the latest firmware.
When using the BD-LIVE service, an error occurs.	<ul style="list-style-type: none">• The memory device must have at least 1GB of free space to accommodate the BD-LIVE service. You can check the available size in Delete BD Data. (See page 27)
Recording	
"Performance test failed." message appears, and also Schedule Recording / recording and Timeshift function does not work.	<ul style="list-style-type: none">• Using lower quality USB storage device not supporting Recording function can cause this kind of problem. It is recommended to use USB HDD storage device.• Recommended specification of USB HDD is at least 5400 rpm. USB HDD of RAID type is not supported.

NOTE

- ▶ When the factory default settings are restored, all stored user BD data is deleted.

Repairs

If you contact us to repair your product, an administration fee may be charged if either:

1. An engineer is called out to your home at your request and there is no defect in the product.
2. You bring the unit to a repair centre and there is no defect in the product.

We will provide you with the amount of the administration fee before we make a home visit or begin any work on your product.

We recommend you read this manually thoroughly, search for a solution on line at www.samsung.com, or contact Samsung Customer Care before seeking to repair your product.

Specifications

General	Weight	3.2 Kg
	Dimensions	430 (W) X 300 (D) X 59 (H) mm
	Operating Temperature Range	+5°C to +35°C
	Operating Humidity Range	10 % to 75 %
HDMI	Video	Resolution : 1080p, 1080i, 720p, 576p/480p
	Audio	PCM, Bitstream
Video Output	Composite Video (Analogue)	RCA Terminal, 1.0Vp-p (75ohm load) Resolution : 576i/480i
Audio Output	Analogue	RCA Terminal, 2 Channel (2Vrms ± 10%)
	Digital	TOS-Link Optical
Network	Ethernet	100BASE-TX Terminal
	Wireless LAN	Built-in
	Security	WEP(OPEN/SHARED) WPA-PSK(TKIP/AES) WPA2-PSK(TKIP/AES)
	WPS(PBC)	Supported
HDD Capacity	BD-E8500A	500GB
	BD-E8900A	1TB

- Network speeds equal to or below 10Mbps are not supported.
- Design and specifications are subject to change without prior notice.
- For the power supply and power consumption, refer to the label attached to the product.
- Weight and dimensions are approximate.



Contact SAMSUNG WORLD WIDE

If you have any questions or comments relating to Samsung products, please contact the SAMSUNG customer care center.

Area	Contact Centre ☎	Web Site
▪ Asia Pacific		
AUSTRALIA	1300 362 603	www.samsung.com
NEW ZEALAND	0800 SAMSUNG (0800 726 786)	www.samsung.com
CHINA	400-810-5858	www.samsung.com
HONG KONG	(852) 3698 4698	www.samsung.com/hk www.samsung.com/hk_en/
INDIA	1800 1100 11 3030 8282 1800 3000 8282 1800 266 8282	www.samsung.com
INDONESIA	0800-112-8888 021-5699-7777	www.samsung.com
MALAYSIA	1800-88-9999	www.samsung.com
PHILIPPINES	1-800-10-SAMSUNG(726-7864) for PLDT 1-800-3-SAMSUNG(726-7864) for Digital 1-800-8-SAMSUNG(726-7864) for Globe 02-5805777	www.samsung.com
SINGAPORE	1800-SAMSUNG(726-7864)	www.samsung.com
THAILAND	1800-29-3232 02-689-3232	www.samsung.com
TAIWAN	0800-329-999 0266-026-066	www.samsung.com
VIETNAM	1 800 588 889	www.samsung.com
▪ Middle East		
U.A.E	800-SAMSUNG (726-7864)	www.samsung.com
OMAN	800-SAMSUNG(726-7864)	www.samsung.com
KUWAIT	183-2255	www.samsung.com
BAHRAIN	8000-4726	www.samsung.com
Egypt	08000-726786	www.samsung.com
JORDAN	800-22273	www.samsung.com
IRAN	021-8255	www.samsung.com
Morocco	080 100 2255	www.samsung.com
Saudi Arabia	9200-21230	www.samsung.com
▪ Africa		
NIGERIA	0800-726-7864	www.samsung.com
Ghana	0800-10077 0302-200077	www.samsung.com
Cote D' Ivoire	8000 0077	www.samsung.com
Senegal	800-00-0077	www.samsung.com
Cameroon	7095- 0077	www.samsung.com
KENYA	0800 724 000	www.samsung.com
UGANDA	0800 300 300	www.samsung.com
TANZANIA	0685 88 99 00	www.samsung.com
SOUTH AFRICA	0860-SAMSUNG(726-7864)	www.samsung.com



AK68-02230H-00